



Lokmanya Tilak Jankalyan Shikshan Sanstha's
PRIYADARSHINI COLLEGE OF ENGINEERING

(Recognised by A.I.C.T.E., New Delhi & Govt. of Maharashtra, Affiliated to R.T.M.Nagpur University)
Near CRPF Campus, Hingna Road, Nagpur-440 019, Maharashtra (India)
Phone : 07104 - 236381, 237307, Fax : 07104 - 237681,
email : principal.pce.ngp@gmail.com, www.pcenagpur.edu.in



6.3.3 Average number of professional development /administrative training programs organized by the institution for teaching and non teaching staff during the last five years

INDEX

Sr.No.	Dates (from-to) (DD-MM-YYYY)	Title of the professional development program organized for teaching staff	Title of the administrative training program organized for non-teaching staff	No. of participants
1	13-06-2018 to 18-06-2018	One week Quality initiative series by IQAC i "Quest for Best".	NA	42
2	15/06/2018 - 06/05/2019	Professional Development Series 1."Colloquium on Approaches to teaching and research in Engineering profession" 2." Honing Language skill using language lab" 3. "NPTEL Courses and SWAYAM Scheme"	NA	65
3	20-06-2019	One day workshop on "Internet of Things and its future aspects"	NA	26
4	15-06-2018	NA	One day workshop on "Component	8



Lokmanya Tilak Jankalyan Shikshan Sanstha's
PRIYADARSHINI COLLEGE OF ENGINEERING

(Recognised by A.I.C.T.E., New Delhi & Govt. of Maharashtra, Affiliated to R.T.M.Nagpur University)
Near CRPF Campus, Hingna Road, Nagpur-440 019, Maharashtra (India)
Phone : 07104 - 236381, 237307, Fax : 07104 - 237681,
email : principal.pce.ngp@gmail.com, www.pcenagpur.edu.in



			Testing and Repair"	
5	19-06-2019	NA	One day workshop on "Internet of Things and their applications".	8
6	15 -03-2019 to 16 -03-2019	National conference on "Recent Trends in Electrical Engineering" (2 Days)	NA	66
7	24 -04-2019 to 26 -04-2019	Three days Faculty Seminar under Journal Club	NA	8
8	11-08-2018	A One day workshop on "Patenting and copy right protection"	NA	55
9	11-06-2019 to 15-06-2019	One week STTP on " Machine Learning : Mathematical Modeling and Implementation"	NA	42
10	29-06-2019	NA	One day workshop on "Website Development" for Non Teaching Staff	23
11	07-12-2018	NA	One day Workshop on "Computer skills enhancement for non-teaching staff".	25



Lokmanya Tilak Jankalyan Shikshan Sanstha's
PRIYADARSHINI COLLEGE OF ENGINEERING

(Recognised by A.I.C.T.E., New Delhi & Govt. of Maharashtra, Affiliated to R.T.M.Nagpur University)
Near CRPF Campus, Hingna Road, Nagpur-440 019, Maharashtra (India)
Phone : 07104 - 236381, 237307, Fax : 07104 - 237681,
email : principal.pce.ngp@gmail.com, www.pcenagpur.edu.in



12	11-12-2018	One day Workshop on "Data Management and Analysis Tools for Research"	NA	21
13	29-04-2019	NA	One day Workshop on "Social Skills".	10
14	19-06-2019	One day Workshop on "Curriculum Development for Applied Mathematics for B. E. First year".	NA	40
15	18-06-2018 to 13-03-2019	Series on Manufacturing and Maintenance, i)"Twin Manufacturing" by MTAB ii)" Industrial Robotics and Automation" by MTAB iii)"Self Reliance in military & civil Aviation Maintenance"	NA	36
16	29-12-2018	NA	Training program for supporting staff on "Introduction to pelton turbine"(HM Lab)	7
17	27-04-2019	NA	Training program for supporting staff on "Torsion Testing Machine" (MOM Lab)	7



Lokmanya Tilak Jankalyan Shikshan Sanstha's
PRIYADARSHINI COLLEGE OF ENGINEERING

(Recognised by A.I.C.T.E., New Delhi & Govt. of Maharashtra, Affiliated to R.T.M.Nagpur University)
Near CRPF Campus, Hingna Road, Nagpur-440 019, Maharashtra (India)
Phone : 07104 - 236381, 237307, Fax : 07104 - 237681,
email : principal.pce.ngp@gmail.com, www.pcenagpur.edu.in



18	13/06/2018 to 14/06/2018	Two days FDP on Quest for Best		42
19	05-10-2018 to 23-04-2019	Technical series i)“Recent Trends in Embedded System and IoT”, ii)Two days STTP on " Additive Manufacturing", iii)Two days STTP on " Solid Modelling using solid works"	NA	25 & 13 & 20
20	08-12-2018	One day workshop on “Different types of patents & their uses”.	NA	11
21	22-12-2018	NA	One day workshop on “ Professional motivation and work ethics.	28
22	30-03-2019	NA	One day workshop on “English Speaking”	28



**Lokmanya Tilak Jankalyan Shikshan Sanstha's
PRIYADARSHINI COLLEGE OF ENGINEERING**

(Recognised by A.I.C.T.E., New Delhi & Govt. of Maharashtra, Affiliated to R.T.M.Nagpur University)
Near CRPF Campus, Hingna Road, Nagpur-440 019, Maharashtra (India)
Phone : 07104 - 236381, 237307, Fax : 07104 - 237681,
email : principal.pce.ngp@gmail.com, www.pcenagpur.edu.in



1. One week Quality initiative series by IQAC "Quest for Best".

Priyadarshini College of Engineering
Mechanical Engineering Department
Under
Priyadarshani Center of Excellence
QUEST FOR THE BEST
Road to Excellence
Road to Excellence
Faculty Development Programme - 2018 - 19



Lokmanya Tilak Jankalyan Shikshan Sanstha's
PRIYADARSHINI COLLEGE OF ENGINEERING

(Recognised by A.I.C.T.E., New Delhi & Govt. of Maharashtra, Affiliated to R.T.M.Nagpur University)
Near CRPF Campus, Hingna Road, Nagpur-440 019, Maharashtra (India)
Phone : 07104 - 236381, 237307, Fax : 07104 - 237681,
email : principal.pce.ngp@gmail.com, www.pcenagpur.edu.in



Quest for Best

Sr. No	Name	Designation & Name of the Institute
1	Dr. K. S. Zakiuddin	HOD, Priyadarshini College of Engineering
2	Dr. I. A. Khan	Associate Professor, Priyadarshini College of Engineering
3	Dr. C. N. Sakhale	Associate Professor, Priyadarshini College of Engineering
4	Dr. M. S. Giripunje	Assistant Professor, Priyadarshini College of Engineering
5	Dr. P. S. Chaudhari	Assistant Professor, Priyadarshini College of Engineering
6	Prof. N. R. Pathare	Assistant Professor, Priyadarshini College of Engineering
7	Prof. P. B. Khope	Assistant Professor, Priyadarshini College of Engineering
8	Prof. Wasim Sheikh	Assistant Professor, Priyadarshini College of Engineering
9	Prof. Nakul Mahalle	Assistant Professor, Priyadarshini College of Engineering
10	Prof. N. S. Sawarkar	Assistant Professor, Priyadarshini College of Engineering
11	Prof. D. M. Hajare	Assistant Professor, Priyadarshini College of Engineering
12	Prof. Rizwan Farooqui	Assistant Professor, Priyadarshini College of Engineering
13	Prof. G. T. Dhanuskar	Assistant Professor, Priyadarshini College of Engineering
14	Prof. A. S. Nilewar	Assistant Professor, Priyadarshini College of Engineering
15	Prof. L. D. Gabhane	Assistant Professor, Priyadarshini College of Engineering
16	Prof. S. B. Jawlekar	Assistant Professor, Priyadarshini College of Engineering
17	Prof. R. S. Tupkar	Assistant Professor, Priyadarshini College of Engineering
18	Prof. H. K. Dubey	Assistant Professor, Priyadarshini College of Engineering
19	Prof. S. V. Sontakke	Assistant Professor, Priyadarshini College of Engineering
20	Prof. S. P. Lokhande	Assistant Professor, Priyadarshini College of Engineering
21	Prof. P. P. Shirpurkar	Assistant Professor, Priyadarshini College of Engineering
22	Prof. C. K. Tembhurkar	Assistant Professor, Priyadarshini College of Engineering
23	Prof. P. Borkar	Assistant Professor, Priyadarshini College of Engineering
24	Prof. V. S. Shende	Assistant Professor, Priyadarshini College of Engineering
25	Prof. M. S. Matey	Assistant Professor, Priyadarshini College of Engineering
26	Prof. S.S. Dongre	Assistant Professor, Priyadarshini College of Engineering
27	Prof. A. Adhaye	Assistant Professor, Priyadarshini College of Engineering
28	Prof. D. K. Padhal	Assistant Professor, Priyadarshini College of Engineering
29	Prof. S. G. Ughade	Assistant Professor, Priyadarshini College of Engineering



**Lokmanya Tilak Jankalyan Shikshan Sanstha's
PRIYADARSHINI COLLEGE OF ENGINEERING**

(Recognised by A.I.C.T.E., New Delhi & Govt. of Maharashtra, Affiliated to R.T.M.Nagpur University)
Near CRPF Campus, Hingna Road, Nagpur-440 019, Maharashtra (India)
Phone : 07104 - 236381, 237307, Fax : 07104 - 237681,
email : principal.pce.ngp@gmail.com, www.pcenagpur.edu.in





**Lokmanya Tilak Jankalyan Shikshan Sanstha's
PRIYADARSHINI COLLEGE OF ENGINEERING**

(Recognised by A.I.C.T.E., New Delhi & Govt. of Maharashtra, Affiliated to R.T.M.Nagpur University)
Near CRPF Campus, Hingna Road, Nagpur-440 019, Maharashtra (India)
Phone : 07104 - 236381, 237307, Fax : 07104 - 237681,
email : principal.pce.ngp@gmail.com, www.pcenagpur.edu.in



2. Professional Development Series

- i)"Colloquium on Approaches to teaching and research in Engineering profession"
- ii)" Honing Language skill using language lab"
- iii)"NPTEL Courses and SWAYAM Scheme"



**Lokmanya Tilak Jankalyan Shikshan Sanstha's
PRIYADARSHINI COLLEGE OF ENGINEERING**

(Recognised by A.I.C.T.E., New Delhi & Govt. of Maharashtra, Affiliated to R.T.M.Nagpur University)
Near CRPF Campus, Hingna Road, Nagpur-440 019, Maharashtra (India)
Phone : 07104 - 236381, 237307, Fax : 07104 - 237681,
email : principal.pce.ngp@gmail.com, www.pcenagpur.edu.in



**Lokmanya Tilak Jankalyan Shikshan Sanstha's
PRIYADARSHINI COLLEGE OF ENGINEERING**
Priyadarshini Campus, Dighodh Hills, Hingna Road, Nagpur-440019
www.pcenagpur.edu.in

Professional Development Series

Details of Session

Session 1

Title of Webinar:- "Colloquium on Approaches to teaching and research in Engineering profession"

Eminent Speaker:- Dr. J.P. Modak, PCE Nagpur

Session 2

Title of Webinar:- "Honing Language skill using language lab"

Eminent Speaker:-Dr. Dora Thompson, PCE Nagpur

Session 3

Title of Webinar:- "NPTEL Courses and SWAYAM Scheme"

Eminent Speaker:-Dr. P. Khone, PCE Nagpur



**Lokmanya Tilak Jankalyan Shikshan Sanstha's
PRIYADARSHINI COLLEGE OF ENGINEERING**

(Recognised by A.I.C.T.E., New Delhi & Govt. of Maharashtra, Affiliated to R.T.M.Nagpur University)
Near CRPF Campus, Hingna Road, Nagpur-440 019, Maharashtra (India)
Phone : 07104 - 236381, 237307, Fax : 07104 - 237681,
email : principal.pce.ngp@gmail.com, www.pcenagpur.edu.in



i) One day Training Program for Faculties- "Colloquium on Approaches to teaching and research in Engineering profession" by PCE.



**Lokmanya Tilak Jankalyan Shikshan Sanstha's
PRIYADARSHINI COLLEGE OF ENGINEERING**
(Recognised by A.I.C.T.E., New Delhi & Govt. of Maharashtra, Affiliated to R.T.M.Nagpur University)
Near CRPF Campus, Hingna Road, Nagpur-440 019, Maharashtra (India)
Phone : 07104 - 236381, 237307, Fax : 07104 - 237681,
email : principal.pce.ngp@gmail.com, www.pcenagpur.edu.in



Internal Quality Assurance Cell

Event: A COLLOQUIUM on "Approach to teaching and research in Engineering field"

Organized by: IQAC , & Dept of Electronics Engg.,Priyadarshini College of Engineering, Nagpur.

Participants : Faculty members of different colleges.

Date: 15-06-2018

Objectives: To give exposure to the faculty about Research and different methodology to be used in research.

Resource Persons: Dr.J.P.Modak, Dean (R&D) Dr.S.S.Shriramwar, Dean Academics & IQAC coordinator, Mrs.Vrushali Nasre (Dept E &T)Assit .Prof.

Remark: The faculties from various colleges of Nagpur Participated . Dr.J.P.Modak Shared new concept and approach of research by using VHDL with AMS simulation. Dr.S.S.Shriramwar talked on Advantages and further scope of FPGA based design. Mrs.Vrushali Nasare shared various new techniques and software used in Analog designing.



Outcome: In this Event, faculties shared their knowledge, got their doubts cleared. They came to know about different areas of research. They were asked to work in these areas.

Dr.S.S.Shriramwar
IQAC Coordinator



**Lokmanya Tilak Jankalyan Shikshan Sanstha's
PRIYADARSHINI COLLEGE OF ENGINEERING**

(Recognised by A.I.C.T.E., New Delhi & Govt. of Maharashtra, Affiliated to R.T.M.Nagpur University)
Near CRPF Campus, Hingna Road, Nagpur-440 019, Maharashtra (India)
Phone : 07104 - 236381, 237307, Fax : 07104 - 237681,
email : principal.pce.ngp@gmail.com, www.pcenagpur.edu.in



ii) Faculty Development Programme on "Honing Language skill using language lab".

Priyadarshini College of Engineering, Nagpur

Department of Humanities

Report

Faculty Development Programme

Department: Humanities

Date: 07-12-2018 & 08-12-2018

Participated by: Faculty members of different departments of PCE

Venue: Language Lab, Civil Building, Wing-D, PCE

Event: Two Days Faculty Development Programme on "Honing Language Skills using Language Lab"

Purpose/ Objective: The purpose of organizing the FDP was to revise and polish the language skills of faculty members so as to use error-free English.

No. of Participants: 60

Resource Person: Dr. Dora Thompson



Conclusion/ Remark: The activity enabled the participants to understand the different elements of common errors in English Language. |



**Lokmanya Tilak Jankalyan Shikshan Sanstha's
PRIYADARSHINI COLLEGE OF ENGINEERING**

(Recognised by A.I.C.T.E., New Delhi & Govt. of Maharashtra, Affiliated to R.T.M.Nagpur University)
Near CRPF Campus, Hingna Road, Nagpur-440 019, Maharashtra (India)
Phone : 07104 - 236381, 237307, Fax : 07104 - 237681,
email : principal.pce.ngp@gmail.com, www.pcenagpur.edu.in



iii) One day workshop on “NPTEL Courses and SWAYAM Scheme”.

Department Organized: Electronics and Telecommunication Engineering
Participated By: Twenty four staff members from the institute participated.
Venue: Electronics and Telecommunication Department, Priyadarshini CoE, Nagpur.
Dated: 6 May 2019
Event: One day seminar on “NPTEL Courses and SWAYAM Scheme”
Purpose: To get aware of the courses offered by NPTEL and their benefits.
Resource Persons: Dr.Praveen Khope, Dept. of Mchanical Engineering, Priyadarshini CoE, Nagpur.

Remarks/Conclusion:

1. Various NPTEL Courses along with Registration and certification Process were discussed.



**Lokmanya Tilak Jankalyan Shikshan Sanstha's
PRIYADARSHINI COLLEGE OF ENGINEERING**

(Recognised by A.I.C.T.E., New Delhi & Govt. of Maharashtra, Affiliated to R.T.M.Nagpur University)
Near CRPF Campus, Hingna Road, Nagpur-440 019, Maharashtra (India)
Phone : 07104 - 236381, 237307, Fax : 07104 - 237681,
email : principal.pce.ngp@gmail.com, www.pcenagpur.edu.in



3. One day workshop on “Internet of Things and its future Aspects”

Department Organized: Electronics and Telecommunication Engineering
Participated By: Twenty Six staff members from the institute and industry participated.
Venue: Electronics and Telecommunication Department, Priyadarshini CoE.Nagpur.
Dated: 20 June 2019
Event: One day seminar on “Internet of Things and its Future Aspects”
Purpose: To get aware of the scope of Internet of things
Resource Persons: Mr.Raj Arora , Rewat Networks, Nagpur.

Remarks/Conclusion:
1. The Future scope of the IoT were Discussed.

Ashwani
Mrs. A.H. Chabhawala
Coordinator.

V.K. Taksande
Dr. V. K. Taksande
HOD EST
H.O.D.,
Deptt. of EST
Priyadarshini College of
Engineering, Nagpur



**Lokmanya Tilak Jankalyan Shikshan Sanstha's
PRIYADARSHINI COLLEGE OF ENGINEERING**

(Recognised by A.I.C.T.E., New Delhi & Govt. of Maharashtra, Affiliated to R.T.M.Nagpur University)
Near CRPF Campus, Hingna Road, Nagpur-440 019, Maharashtra (India)
Phone : 07104 - 236381, 237307, Fax : 07104 - 237681,
email : principal.pce.ngp@gmail.com, www.pcenagpur.edu.in



4. One day workshop on "Component Testing and Repair"

③

ONE PAGE REPORT 18-19

Organized By: Electronics and Telecommunication Engineering.

Attended By: Non Teaching staff of the department.

Venue: Seminar Hall (E&TC Dept), Wing E , Rajiv Gandhi IT Complex.
Date: 15/6/2018

Event: One Day Workshop on Component Testing & Repair .

Resource Person :- Mr. Vishal Panchbhai, PCE. Nagpur

Purpose: To learn the basic application and testing of component and how it is useful in mini project .

Conducted by: Dr. Pravin P. Ashtankar (E&TC)

Remarks/Conclusion: Mr. Vishal Panchbhai give the brief information about component testing and soldering and explain its application in design of mini project.

Dr. P.P. Ashtankar
Co-ordinator

Dr. V.K. Taksande
HOD ETC



**Lokmanya Tilak Jankalyan Shikshan Sanstha's
PRIYADARSHINI COLLEGE OF ENGINEERING**

(Recognised by A.I.C.T.E., New Delhi & Govt. of Maharashtra, Affiliated to R.T.M.Nagpur University)
Near CRPF Campus, Hingna Road, Nagpur-440 019, Maharashtra (India)
Phone : 07104 - 236381, 237307, Fax : 07104 - 237681,
email : principal.pce.ngp@gmail.com, www.pcenagpur.edu.in



5. One day workshop on " Internet of Things and their applications".

ONE PAGE REPORT 19-20

Organized By:Electronics and Telecommunication Engineering.

Attended By:Non Teaching staff of the department.

Venue: Seminar Hall (E&TC Dept),Wing E , Rajiv Gandhi IT Complex.

Date: 19/6/2019

Event: One Day Workshop on **Internet of Things & their Application .**

Resource Person :-Mr.Raj Arora,Director,Revat Network.Nagpur

Purpose: To learn the basic application **Internet of Things** and how it is useful in mini project .

Conducted by: Dr.Pravin P. Ashtankar (E&TC)



Remarks/Conclusion:Mr.Raj Arora ,give the brief information about Internet of Things and explain its application in design of mini project.

Dr.P.P.Ashtankar

Dr. V.K.Taksande



Lokmanya Tilak Jankalyan Shikshan Sanstha's
PRIYADARSHINI COLLEGE OF ENGINEERING

(Recognised by A.I.C.T.E., New Delhi & Govt. of Maharashtra, Affiliated to R.T.M.Nagpur University)
Near CRPF Campus, Hingna Road, Nagpur-440 019, Maharashtra (India)
Phone : 07104 - 236381, 237307, Fax : 07104 - 237681,
email : principal.pce.ngp@gmail.com, www.pcenagpur.edu.in



6. Two days National conference on “Recent Trends in Electrical Engineering”

Priyadarshini College of Engineering, Nagpur
Department of Electrical Engineering
In association with
The Institution of Engineers
Nagpur Local Center, Nagpur
National Conference on
"Recent Trends in Electrical Engineering"
on
15th and 16th March, 2019.

Total No. of papers :65

Guest:

Dr.R.L.Srivatsava, Chairman, The Institution of Engineer, Nagpur Local Centre, Nagpur.

Dr.H.M.Suryawanshi, Professor ,VNIT, Nagpur

Dr.M.P.Singh Principal, P.C.E, Nagpur.

Dr.S.A.Dhale, Vice Principal, PCE, Nagpur

Convenor:

Dr. K. B. Porate, Professor and HoD, Electrical Engineering

Objectives:

Electrical System has gone through rapid technical advances; the applications are fast expanding in industrial, commercial and utility environments. The utilisation of electrical energy should be optimised and conserved by means of advanced control technique and technology.

The objective of this conference is

1. To provide a platform for students and eminent researchers to present their work.
2. To interact and update themselves about various upcoming technologies in the field of Electrical Engineering.
3. To be aware of scope for advancement in the presented work.
4. To make UG students aware of how to write a technical paper and develop presentation skill by delivering paper in conference.

Organising Secretary:

Dr.R.A.Keswani

Prof.U.E.Hiwase



**Lokmanya Tilak Jankalyan Shikshan Sanstha's
PRIYADARSHINI COLLEGE OF ENGINEERING**

(Recognised by A.I.C.T.E., New Delhi & Govt. of Maharashtra, Affiliated to R.T.M.Nagpur University)
Near CRPF Campus, Hingna Road, Nagpur-440 019, Maharashtra (India)
Phone : 07104 - 236381, 237307, Fax : 07104 - 237681,
email : principal.pce.ngp@gmail.com, www.pcenagpur.edu.in





**Lokmanya Tilak Jankalyan Shikshan Sanstha's
PRIYADARSHINI COLLEGE OF ENGINEERING**

(Recognised by A.I.C.T.E., New Delhi & Govt. of Maharashtra, Affiliated to R.T.M.Nagpur University)
Near CRPF Campus, Hingna Road, Nagpur-440 019, Maharashtra (India)
Phone : 07104 - 236381, 237307, Fax : 07104 - 237681,
email : principal.pce.ngp@gmail.com, www.pcenagpur.edu.in



7.Three days Faculty Seminar under Journal Club

PRIYADARSHINI COLLEGE OF ENGINEERING
Priyadarshini campus, Diggoh hills, Hingna Road, Nagpur - 440019
Ph: + 91-7194-236381 / 237307, Fax: + 91-7194-237681
E-mail - principal.pce@hjsa.net / www.pce.hjsa.net

DEPARTMENT OF CIVIL ENGINEERING Date:18/04/19

All the faculties are hereby informed that the faculty member seminar under journal club is scheduled on 25th April and 26th April 2019. Faculty should have to deliver a seminar on any high impact international journal paper based on their specialization or area of research.

Schedule for faculty seminar under Journal Club

Name of faculty	Date	Time	Sign
Dr. S. A. Dhale	25/04/19	11:00 am	
Prof. V.S. Ghutke	25/04/19	12:00 noon	
Prof. V.A. Ganvir	25/04/19	02:00 pm	
Prof. P.S. Bhandari	25/04/19	03:00 pm	
Prof. V.R. Agrawal	26/04/19	11:00 am	
Prof. Vikrant Vairagade	26/04/19	12:00 noon	
Dr. Sarika Modak	26/04/19	02:00 pm	
Dr. P.T. Dhorabe	26/04/19	03:00 pm	

H.O.D.
Civil Engg. Dept.
H.O.D. Civil Engineering
Priyadarshini College of Engineering
Nagpur



Lokmanya Tilak Jankalyan Shikshan Sanstha's
PRIYADARSHINI COLLEGE OF ENGINEERING

(Recognised by A.I.C.T.E., New Delhi & Govt. of Maharashtra, Affiliated to R.T.M.Nagpur University)
Near CRPF Campus, Hingna Road, Nagpur-440 019, Maharashtra (India)
Phone : 07104 - 236381, 237307, Fax : 07104 - 237681,
email : principal.pce.ngp@gmail.com, www.pcenagpur.edu.in



PRIYADARSHINI COLLEGE OF ENGINEERING
Priyadarshini campus, Digidoh hills, Hingna Road, Nagpur- 440019
Ph: + 91-7104-236381 / 237307 Fax: + 91-7104-237681
E-mail: principal.pce@tjss.net / www.pce.tjss.net

DEPARTMENT OF CIVIL ENGINEERING

Attendance for faculty seminar under Journal Club 25th April 2019

Sr.No.	Name of faculty	Sign
1	Dr. S. J. Modale	<i>S. J. Modale</i>
2	Manisha E. Chinchhaxe	<i>Manisha</i>
3	Veena Jyani	<i>Veena</i>
4	Dr. P. T. Dhorabe	<i>P. T. Dhorabe</i>
5	V. S. Vaisode	<i>V. S. Vaisode</i>
6	P. S. Bhaskar	<i>P. S. Bhaskar</i>
7	Amol P. Kedar	<i>Amol P. Kedar</i>
8	Kirti Thakare	<i>Kirti Thakare</i>
9	Alaka Das	<i>Alaka Das</i>
10	R. S. Dhapurekar	<i>R. S. Dhapurekar</i>
11	N. S. Ghutke	<i>N. S. Ghutke</i>
12	V. R. Agrawal	<i>V. R. Agrawal</i>

[Signature]
H.O.D.
Civil Engg. Dept.



**Lokmanya Tilak Jankalyan Shikshan Sanstha's
PRIYADARSHINI COLLEGE OF ENGINEERING**

(Recognised by A.I.C.T.E., New Delhi & Govt. of Maharashtra, Affiliated to R.T.M.Nagpur University)
Near CRPF Campus, Hingna Road, Nagpur-440 019, Maharashtra (India)
Phone : 07104 - 236381, 237307, Fax : 07104 - 237681,
email : principal.pce.ngp@gmail.com, www.pcenagpur.edu.in



8.A One day workshop on "Patenting and copy right protection"

Priyadarshini College of Engineering
Near C.R.P.F. Campus, Hingna Road, Nagpur
Department of Computer Technology

Notice Date: 9/8/2018

It is to informed that "A One day Workshop on Patenting and Copyright Protection " has been organized on 11/8/2018 by the Computer Technology Department. You are requested to attend the same, details of the Worksnop is as follows-

Name: "A One day Workshop on Patenting and Copyright Protection"
Date: 11/8/2018
Time: 11:00 AM onwards
Venue: CI Seminar Hall, IT building, PCE

Jadhav
Prof. J.P.Gadhane
Prof. T. Irkhede
Coordinator

Mhays
Dr. (Mrs.) N. M. Thakore
HOD (CI)

S
10/10/18

Copy to : HoD IT/ET/EN/AERO/ME Shift I/Shift II/CIVIL
Pantale
10/8/18



Lokmanya Tilak Jankalyan Shikshan Sanstha's
PRIYADARSHINI COLLEGE OF ENGINEERING

(Recognised by A.I.C.T.E., New Delhi & Govt. of Maharashtra, Affiliated to R.T.M.Nagpur University)
 Near CRPF Campus, Hingna Road, Nagpur-440 019, Maharashtra (India)
 Phone : 07104 - 236381, 237307, Fax : 07104 - 237681,
 email : principal.pce.ngp@gmail.com, www.pcenagpur.edu.in



Priyadarshini College of Engineering
 Near C.R.P.F. Campus, Hingna Road, Nagpur

Department of Computer Technology
 " A One day Workshop on Patenting and Copyright Protection "

Session: II Date: 11/8/13

Sr.No.	Name of Faculty	Department	Sign
1.	MRS. PRITEE. S. GOTEKAR	ELECTRICAL	
2.	MR. L. J. Vaidyar	Electrical	
3.	Ms. Priya. P. Gaikwad	Electrical	
4.	Mr. Vikash R. Agrawal	Civil	
5.	MR. Amol Kedar	Civil	
6.	Mrs. S.S. Soley	APP Physics	
7.	DR.(Mrs.) S.S. Joshi	App. Physics	
8.	Mr. Chetan K. Pombhakar	Mechanical Engg	
9.	Sagar D. Shelare	Mechanical Engg	
10.	Dr. (Mrs) Manisha Joshi	Chemistry	
11.	Dr. (Mrs) Jayashri Kanfode	Chemistry	
12.	Dr. (Mrs) Priyanka Warnekar	Chem	
13.	V. S. Vaidgude	Civil Engg	
14.	V. S. Ghutke	Civil Engg.	
15.	N. A. Ghodichor	CT dept	
16.	M. Panjwani	CT	
17.	S. B. Jaisalekar	ME	
18.	Ms. D. K. Patil	Electrical	
19.	Ms. R. S. Pawar	Electrical	
20.	Dr. Seema Shrivastava	Chem.	
21.	Mrs. A. V. Dehankar	CT	
22.	Ms. H. Usade	CT	
23.	Mrs. Vaishali Jadhav	CT	
24.	Mr. Amit Kumar	CT	
25.	Mr. Roman Janbandhy	Hum	
26.	Dr. Dora Thompson	Hum	
27.	Jogi John	CT	



Lokmanya Tilak Jankalyan Shikshan Sanstha's
PRIYADARSHINI COLLEGE OF ENGINEERING

(Recognised by A.I.C.T.E., New Delhi & Govt. of Maharashtra, Affiliated to R.T.M.Nagpur University)
Near CRPF Campus, Hingna Road, Nagpur-440 019, Maharashtra (India)
Phone : 07104 - 236381, 237307, Fax : 07104 - 237681,
email : principal.pce.ngp@gmail.com, www.pcenagpur.edu.in



Priyadarshini College of Engineering, Nagpur
Department of Computer Technology

“A One day Workshop on Patenting and Copyright Protection ”

(Session 2018-19)

Impact Analysis

Topic Name : “A One day Workshop on Patenting and Copyright Protection ”

Name of Event coordinator: Mrs.J.P.Gabhane,Ms.T.Irkhede

Name of Resource Person : Prof (Mrs.)Rubana Khan ,Assistant Professor,PCE ,Nagpur

Total no of Participants : 55

Sr. No	Feedback Point	Excellent	Good	Satisfactory	Overall Impact
1	The relevance of methodology used by expert the topic	47	08	0	2.8
2	Quality of Lectures Considering the concept,knowledge,analytic abilities and broadening prespectives	33	20	2	2.6
3	Presentation Skill	38	15	2	2.6
4	Effectiveness of discussion with participants	38	15	2	2.6
5	Overall Presentation	38	17	0	2.6
Average of overall impact : 2 . 6 (Excellent)					

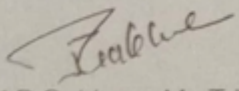
Mrs.J.P.Gabhane,Ms.T.Irkhede
Event Coordinator

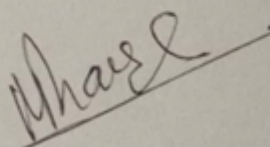
Dr.(Mrs.) Nita Thakare
HOD CT



Lokmanya Tilak Jankalyan Shikshan Sanstha's PRIYADARSHINI COLLEGE OF ENGINEERING

(Recognised by A.I.C.T.E., New Delhi & Govt. of Maharashtra, Affiliated to R.T.M.Nagpur University)
Near CRPF Campus, Hingna Road, Nagpur-440 019, Maharashtra (India)
Phone : 07104 - 236381, 237307, Fax : 07104 - 237681,
email : principal.pce.ngp@gmail.com, www.pcenagpur.edu.in



9. One week STTP on “Machine Learning : Mathematical Modelling and Implementation”.

ABOUT STTP

Machine learning is a field which gives computers the ability to learn and make predictions on data. Machine learning allows software applications to become more accurate in predicting outcomes without being explicitly programmed. The basic premise of machine learning is to build algorithms that can receive input data and use statistical analysis to predict an output value within an acceptable range. Conversion of real world phenomena under certain conditions into mathematical formulation is known as Mathematical Modeling. This STTP is aimed at giving theoretical knowledge as well as hands-on training to the Faculty Members and Research Scholars on various aspects of mathematical Modeling with machine learning techniques.

OBJECTIVE

The Main Objectives of this STTP is to understand fundamentals of Mathematical Modeling, to develop mathematical Model for real word problem, to use machine learning techniques for building computer applications.

COURSE CONTENT

Understanding the Concept and Purpose of Mathematical Modeling, To develop, solve/analyze a mathematical model of the real-life problem/ system ,Machine Learning concepts and Implementation, Lab sessions using R programming , Python and other machine learning tools, Mathematical modeling and implementation of case studies/demos by Experts from NEERI and IT Industry, Visit to NEERI, Nagpur

PARTICIPANTS

The course is of interdisciplinary in nature. Teachers/Research Scholars from various streams of science and engineering colleges, polytechnics, science colleges and professionals from industries can apply for the course.

ABOUT INSTITUTE



The Priyadarshini College of Engineering, Nagpur, one of the leading Engineering College, in the progressive and most competitive State of Maharashtra, established in 1990. It has been accredited by A+ grade By NAAC and has been conferred "A" grade by the Government of Maharashtra on the basis of distinct infrastructure and academic achievements. College has Mechanical Engineering, Civil Engineering, Computer Technology, Electrical Engineering, Electronics Engineering, Electronics and Telecommunication Engineering, and Information Technology departments. The Departments are accredited by National Board of Accreditation, New Delhi for Three years. The setup of Priyadarshini campus is developed on a sprawling 72-acres hilly terrain at Nagpur – the orange city.

ABOUT DEPARTMENT

The Department of Computer Technology was established in 1990 .Computer Technology department has a setup to provide advanced computer education to the students. The department has state-of-the-art laboratories, well qualified and experienced faculties and staff to cater to the above requirements. Computer Technology department has a very vibrant students' forum SCOoP which organizes co-curricular and extra-curricular activities. The placement scenario of the Computer Technology students is also quite encouraging as maximum students are placed in various prestigious organizations of IT sector .In a nutshell, the department strives to create an ambience that provides opportunities for all-round development of students to face the competitive world.



LTJSS's
**Priyadarshini College of Engineering
NAGPUR**

AICTE- ISTE Approved
Self-Financing Short Term Training Program on
“Machine Learning: Mathematical
Modeling and Implementation”



11th June 2019 – 15th June 2019

Organized by
Department of Computer Technology
Priyadarshini College of Engineering , Nagpur
In association with

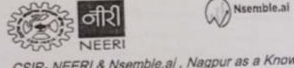

CSIR- NEERI & Nsemble.ai , Nagpur as a Knowledge
partner
Convener
Dr. Nita M.Thakare, HoD [CT]
Coordinator
Mrs. Snehal S. Golait
Co-coordinator
Mr. Puneshkumar U. Tembhare



Lokmanya Tilak Jankalyan Shikshan Sanstha's PRIYADARSHINI COLLEGE OF ENGINEERING

(Recognised by A.I.C.T.E., New Delhi & Govt. of Maharashtra, Affiliated to R.T.M.Nagpur University)
Near CRPF Campus, Hingna Road, Nagpur-440 019, Maharashtra (India)
Phone : 07104 - 236381, 237307, Fax : 07104 - 237681,
email : principal.pce.ngp@gmail.com, www.pcenagpur.edu.in



Priyadarshini College of Engineering, Nagpur

Department of Computer Technology

Organized By: Department of Computer Technology

Event: One week AICTE- ISTE approved STTP on " Machine Learning: Mathematical Modeling and Implementation" in association with CSIR- NEERI ,Nagpur & Nsemble.ai , Nagpur as Knowledge partners .

Date: 11th June 19 to 15th June 19.

Venue: Seminar Hall, ETC Dept. and Programming Language Lab PCE, Nagpur

Participants: Faculties from various Engineering and Polytechnic Colleges.
Total 42 participants

Resource Person: Dr.Aabha Sargaonkar ,Dr.Rajiv Sohani, Mr. Rakesh Kadaverugu,Mr.Asheesh Sharma,Scientist ,CSIR-NEERI,Nagpur , Dr.Mukesh Raghuvanshi,Professor ,YCCE,Nagpur , Dr.Rahila Patel, Associate Professor, ACE,Nagpur, Mr.Pankaj Mehar , Mr.Omkar Mohan Joshi, Mr. Sushrut Ashtikar (AI Devops), Nsemble.ai,Nagpur,

Event Convener: Dr.(Mrs.) Nita M Thakare Event Coordinator: Prof. Snehal S. Golait , Prof. Punesh Tembhe

Purpose/Objective: The Main Objectives of this STTP is to understand fundamentals of Mathematical Modeling, to develop mathematical Model for real word problem, to use machine learning techniques for building computer applications.





**Lokmanya Tilak Jankalyan Shikshan Sanstha's
PRIYADARSHINI COLLEGE OF ENGINEERING**

(Recognised by A.I.C.T.E., New Delhi & Govt. of Maharashtra, Affiliated to R.T.M.Nagpur University)
Near CRPF Campus, Hingna Road, Nagpur-440 019, Maharashtra (India)
Phone : 07104 - 236381, 237307, Fax : 07104 - 237681,
email : principal.pce.ngp@gmail.com, www.pcenagpur.edu.in



Remark/Outcome: After completion of this one week STTP on "Machine Learning : Mathematical modeling and implementation", the participants are able to

- understand complexity of Machine Learning algorithms and their limitations.
- understand modern notions in data analysis oriented computing.
- be capable of confidently applying common Machine Learning algorithms in practice and implementing their own.
- implement real life application using R and Python Programming.
- be capable of performing experiments in Machine Learning using real-world data.

Prof. Punesh Tembhre

Co- Coordinator

Assistant Professor
Dept. of Computer Technology
Priyadarshini College of Engineering
Hingna Road, Nagpur-19

Prof. Snehal Golait

Coordinator

Assistant Professor
Dept. of Computer Technology
Priyadarshini College of Engineering
Hingna Road, Nagpur-19

Dr.(Mrs.) Nita M Thakare

Convener

Head of Department
Dept. of Computer Technology
Priyadarshini College of Engineering
Hingna Road, Nagpur-19



Lokmanya Tilak Jankalyan Shikshan Sanstha's
PRIYADARSHINI COLLEGE OF ENGINEERING

(Recognised by A.I.C.T.E., New Delhi & Govt. of Maharashtra, Affiliated to R.T.M.Nagpur University)
Near CRPF Campus, Hingna Road, Nagpur-440 019, Maharashtra (India)
Phone : 07104 - 236381, 237307, Fax : 07104 - 237681,
email : principal.pce.ngp@gmail.com, www.pcenagpur.edu.in



PRIYADARSHINI COLLEGE OF ENGINEERING, NAGPUR
DEPARTMENT OF COMPUTER TECHNOLOGY

Curricular/Cocurricular Activity

STTP on "Machine Learning: Mathematical Modeling and Implementation"

Session 2018-19

Impact Analysis

Topic Name : Short Term Training Program

Name of the Event Coordinator : Prof.S.Golait, Prof. P. U. Tembhare

Total no of Participants : 31

SN	Feedback Point	5 (Strongly Agree)	4 (Agree)	3 (Not Sure)	2 (DisAgree)	1 (Strongly DisAgree)	Overall Impact
1	I felt that the STTP was well organized and the main points were well covered and clarified.	21	7	1	0	1	4.41
2	I felt that the facilitator demonstrated comprehensive knowledge of the subject matter.	17	13	0	1	0	4.48
3	The facilitator helped me to understand how the STTP Material related to my own Study.	17	13	0	0	0	4.41
4	I felt that the facilitator conveyed ideas effectively and interactively.	21	8	0	1	0	4.48
5	I gained usable skills and will be able to apply them to my academic or personal life.	15	15	1	0	0	4.51
6	The Overall flow of the STTP was well structured to meet the learning outcomes with hands on practice session.	17	13	0	0	0	4.41
7	The Course material provided valuable information to support the STTP.	15	14	1	0	0	4.32
8	The total duration was the current amount of time to cover the subject matter of the workshop.	13	15	0	0	1	4.06
9	The Hospitality was satisfactory.	22	7	1	0	0	4.54
10	The Lab Setup and technical facilities were adequate to meet the requirement of the STTP.	17	13	0	0	0	4.41
11	The venue was comfortable and conducive to learning .	20	10	0	0	0	4.51
12	Food Quality was Good.	22	9	0	0	0	4.7
Average of all impact Point		4.43 (MODERATE)					

Mrs.Snehal S.Golait , Mr.Puneshkumar Tembhare

Event Coordinator

Dr.(Mrs) N.M.Thakare

HOD(CT)



Lokmanya Tilak Jankalyan Shikshan Sanstha's
PRIYADARSHINI COLLEGE OF ENGINEERING

(Recognised by A.I.C.T.E., New Delhi & Govt. of Maharashtra, Affiliated to R.T.M.Nagpur University)
Near CRPF Campus, Hingna Road, Nagpur-440 019, Maharashtra (India)
Phone : 07104 - 236381, 237307, Fax : 07104 - 237681,
email : principal.pce.ngp@gmail.com, www.pcenagpur.edu.in



10. One day workshop on “Website Development” for Non Teaching Staff

PRIYADARSHINI COLLEGE OF ENGINEERING, NAGPUR

DEPARTMENT OF COMPUTER TECHNOLOGY

ACADEMIC SESSION: 2018 - 20' 19

Date: 22/06/2019

NOTICE

All Hods are informed that “One day workshop on Website Development” will be organized for Non Teaching Staff on 29th Jun 2019 at 11:00 am in CT Dept by Prof. Krutika Sapkal . All are requested to make them free to avail the benefits of workshop.

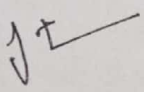
Workshop Coordinator

Mr. Jogi John

Assistant Professor
Dept. of Computer Technology
Priyadarshini College of Engineering
Hingna Road, Nagpur-19

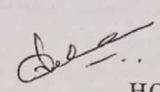
HOD(CT)

Dr. (Mrs.) N.M. Thakare

Head of Department
Dept. of Computer Technology
Priyadarshini College of Engineering
Hingna Road, Nagpur-19

Copy to : ET/IT/EN/EP/ME Shift I/ME Shift II/AERO/CIVIL/First Year/Humanities



Lokmanya Tilak Jankalyan Shikshan Sanstha's
PRIYADARSHINI COLLEGE OF ENGINEERING

(Recognised by A.I.C.T.E., New Delhi & Govt. of Maharashtra, Affiliated to R.T.M.Nagpur University)
Near CRPF Campus, Hingna Road, Nagpur-440 019, Maharashtra (India)
Phone : 07104 - 236381, 237307, Fax : 07104 - 237681,
email : principal.pce.ngp@gmail.com, www.pcenagpur.edu.in



PRIYADARSHINI COLLEGE OF ENGINEERING
DEPARTMENT OF COMPUTER TECHNOLOGY
ATTENDANCE SHEET

"One Day Workshop on " WEBSITE DEVELOPMENT "

Date : 29/06/2019

Sr. No.	Name of Staff	Signature
1)	Rajesh Shrivastava	(Rajesh)
2)	Shrikant Uje	Shrikant
3)	Vitthal B. Sarmade	Vitthal
4)	D.M. Bhadate	D.M.
5)	Ravindra V. Baseshankar	R.V.
6)	Nandee L. Phadnis	N.L.
7)	Sanjay Ghate	Sanjay
8)	Ashish Rewalkar	Ashish
9)	Akshay Kumbhaze	Akshay
10)	Ankur Gonde	Ankur
11)	Deepak Ambekar	Deepak
12)	Ravindra Dhanu Bhanu	R.D.
13)	Maqsood Pathan	Maqsood
14)	Javed Khan	Javed
15)	Umesh Sorte	Umesh
16)	Deepal Sansare	Deepal
17)	Yogesh Ranajdate	Yogesh
18)	Vasant Moholkar	Vasant
19)	Radheshyam Longadje	Radheshyam
20)	Atul Sansare	Atul



Lokmanya Tilak Jankalyan Shikshan Sanstha's
PRIYADARSHINI COLLEGE OF ENGINEERING

(Recognised by A.I.C.T.E., New Delhi & Govt. of Maharashtra, Affiliated to R.T.M.Nagpur University)
Near CRPF Campus, Hingna Road, Nagpur-440 019, Maharashtra (India)
Phone : 07104 - 236381, 237307, Fax : 07104 - 237681,
email : principal.pce.ngp@gmail.com, www.pcenagpur.edu.in



11. One day Workshop on "Computer skills enhancement" for non-teaching staff.

Priyadarshini College of Engineering, Nagpur
Department of Applied Physics

Date: 03/12/2018.

NOTICE

Department of Applied Physics is organizing a one day workshop on "Computer Skills Enhancement For Non Teaching Staff " on date 07/12/2018. The workshop will include sessions on basic computer skills. All the non teaching staff members are informed to attend the workshop.

Details

Date- 07/12/2018
Time - 11:00 a.m.
Venue- Applied Physics Lab, Room NO. 201

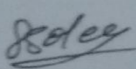
Prof. Swati S. Soley
Coordinator, Workshop

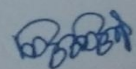
Dr. N.S. Ugemuge
Head, Dept. of Applied Physics

Copy to-
Head of the Department- ME/ CV/ EP/ Aero / CT / IT / ETC / ET / App. Chem /
App. Maths / Humanities



**Lokmanya Tilak Jankalyan Shikshan Sanstha's
PRIYADARSHINI COLLEGE OF ENGINEERING**

(Recognised by A.I.C.T.E., New Delhi & Govt. of Maharashtra, Affiliated to R.T.M.Nagpur University)
Near CRPF Campus, Hingna Road, Nagpur-440 019, Maharashtra (India)
Phone : 07104 - 236381, 237307, Fax : 07104 - 237681,
email : principal.pce.ngp@gmail.com, www.pcenagpur.edu.in



12. One day Workshop on "Data Management and Analysis Tools for Research"

Lokmanya Tilak Jankalyan Shikshan Sanstha's
PRIYADARSHINI COLLEGE OF ENGINEERING, NAGPUR

DEPARTMENT OF APPLIED PHYSICS

Impact Analysis

Event:- ONE DAY WORKSHOP ON "DATA MANAGMENT AND ANALYSIS TOOLS FOR RESEARCH "

Date of Event :- 11/12 /2018

Name Of Coordinator :- Mrs. Swati S. Soley,

Sr. No.	Particular	Substantially (3)	Moderately (2)	Slightly (1)	Overall Impact
1	Was the Speaker good enough to deliver his thought/ views?	18	2	1	2.80
2	Was the work shop Interactive ?	17	2	2	2.71
3	Was the content of workshop useful in research?	18	1	2	2.76
4	Would you like to continue the thoughts given by the speaker?	19	1	1	2.85
Average Impact		2.78			



**Lokmanya Tilak Jankalyan Shikshan Sanstha's
PRIYADARSHINI COLLEGE OF ENGINEERING**

(Recognised by A.I.C.T.E., New Delhi & Govt. of Maharashtra, Affiliated to R.T.M.Nagpur University)
Near CRPF Campus, Hingna Road, Nagpur-440 019, Maharashtra (India)
Phone : 07104 - 236381, 237307, Fax : 07104 - 237681,
email : principal.pce.ngp@gmail.com, www.pcenagpur.edu.in



13. One day Workshop on "Social Skills".

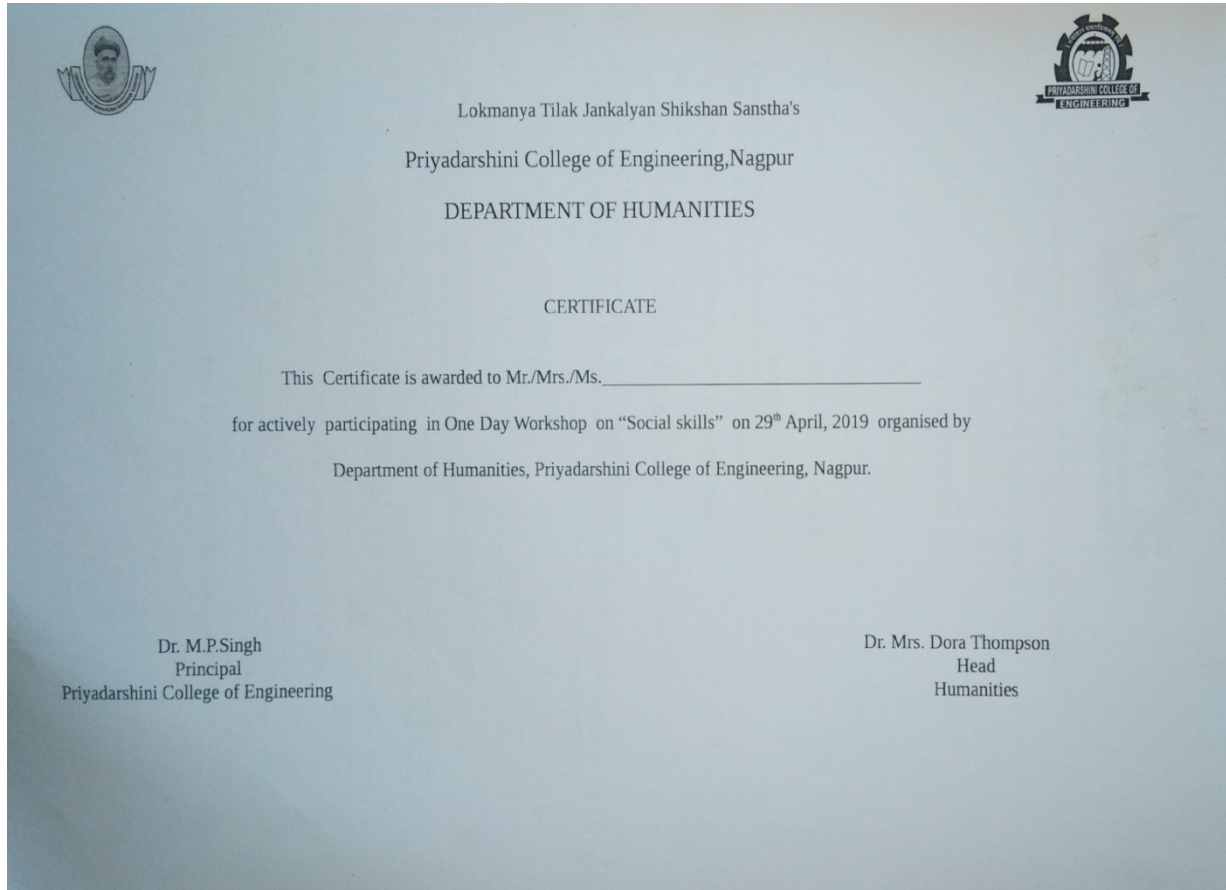



**Lokmanya Tilak Jankalyan Shikshan Sanstha's
PRIYADARSHINI COLLEGE OF ENGINEERING**

(Recognised by A.I.C.T.E., New Delhi & Govt. of Maharashtra, Affiliated to R.T.M.Nagpur University)
Near CRPF Campus, Hingna Road, Nagpur-440 019, Maharashtra (India)
Phone : 07104 - 236381, 237307, Fax : 07104 - 237681,
email : principal.pce.ngp@gmail.com, www.pcenagpur.edu.in



14. One day Workshop on "Curriculum Development for Applied Mathematics for B. E. First year".

PRIYADARSHINI COLLEGE OF ENGINEERING, NAGPUR
Department of Applied Mathematics organising
One day workshop on
"Curriculum Development"
in association with RTMNU for Applied Mathematics-I & II
Date: 19/06/19 Attendance sheet for workshop

Sr. No.	Name of Faculty	College Name	Mobile No.	Email address	University Approval number	Experience in years	Signature
1.	P. Y. Gajbhiye	JIT, Nagpur	7610254886	P.gajbhiye@jit.org.in		10 Yrs	(Signature)
2	Mrs MV Sarode	PIGCE, Nagpur	9881235747	manishav.sarode@gmail.com	1506/1281	12 yrs Exp 17 yrs Total	(Signature)
3	Smita D. Kohale	BDCB, Wardha	9922896504	smit244@gmail.com		10 Yrs	(Signature)
4.	M. LAKSHMI	BDCB; Waranan.	9404353853	chinmulkkyam@gmail.com		8 Yrs	(Signature)
5.	Ajaseen Baig	PBCE, Nagpur	8149212398	ajaseenbaig@gmail.com		06 Yrs	(Signature)
6.	Jaisree Deshmukh	PBCE Nagpur		jaisree15deshmukh@gmail.com		05 Yrs	(Signature)
7	Dr (Mrs) R.V. Harane	PBCE Nagpur	8275284422	ranjanharane@gmail.com		07 Yrs	(Signature)
8.	Shital Yadav	Ghraet, Nagpur	9168324555	shital.yadav@rajsani.net		9 Yrs	(Signature)
9	Yogesh V Rathod	Ghraet, Nagpur	8888737463	Yogesh.rathod@rajsani.net		9 Yrs	(Signature)
10	Mrs.S.S.Kishoragar	KDKCE, Nagpur	9822592389	smita.kishoragar215@gmail.com		32 Yrs	(Signature)
11	Sucheta Mohan	SVPCE, Nagpur	9860774581	mohansucheta92@gmail.com		15 Yrs	(Signature)
12.	Dr. Kirati Sahu	SVPCE, Nagpur	9975041608	kiratisahu123@gmail.com		14 Yrs	(Signature)
13	Dr. Rejali K. Kelkar	S.B.J.I.T.M.R., Nagpur	7709912088	rejalikelkar@sbjit.edu.in		20 Yrs.	(Signature)
14	Monali Thakare/Dhote	DBACER, Nagpur	9823027200	thakaremonali@gmail.com		14 Yrs	(Signature)
15	Dr. Shoma Sen	P.T.E.T., Nagpur	9970425202	shomasen08@gmail.com		18 Yrs	(Signature)
16	Anushree A Senkar	RGCE, Nagpur	9970400690	aseekar_aaa@rediffmail.com		19 Yrs	(Signature)



Lokmanya Tilak Jankalyan Shikshan Sanstha's
PRIYADARSHINI COLLEGE OF ENGINEERING

(Recognised by A.I.C.T.E., New Delhi & Govt. of Maharashtra, Affiliated to R.T.M.Nagpur University)
Near CRPF Campus, Hingna Road, Nagpur-440 019, Maharashtra (India)
Phone : 07104 - 236381, 237307, Fax : 07104 - 237681,
email : principal.pce.ngp@gmail.com, www.pcenagpur.edu.in



Lokmanya Tilak Jankalyan Shikshan Sanstha's
PRIYADARSHINI COLLEGE OF ENGINEERING



"ONE DAY WORKSHOP ON CURRICULUM DEVELOPMENT"
FEEDBACK FORM

Thank you for attending the one day workshop "On Curriculum Development" on date 19/06/2019

We hope that you found the workshop interactive and that we met your expectations. We would be very grateful if you could take a moment to complete the feedback form. Your comments will assist us in improving future events, that we will organize.

Please indicate your impression of the items listed below:

Sr. No.	Particular	Substantially	Moderately	Slightly
1	Was the workshop good enough to participate?	✓		
2	Was the workshop fruitful?	✓		
3	Is the workshop useful in overall syllabus redesign process?		✓	
4	Would you like to continue the participation in such type of events?	✓		

Any other suggestion : Syllabus should be formed according to AICTE prescribed syllabus with a maximum of 5-10% only.

Name of Participant **SATISH J. TIWARI**
Asst. Professor, PCE, Nagpur

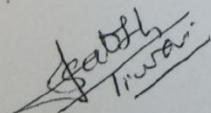
Signature



**Lokmanya Tilak Jankalyan Shikshan Sanstha's
PRIYADARSHINI COLLEGE OF ENGINEERING**

(Recognised by A.I.C.T.E., New Delhi & Govt. of Maharashtra, Affiliated to R.T.M.Nagpur University)
Near CRPF Campus, Hingna Road, Nagpur-440 019, Maharashtra (India)
Phone : 07104 - 236381, 237307, Fax : 07104 - 237681,
email : principal.pce.ngp@gmail.com, www.pcenagpur.edu.in



15.Series on Manufacturing and Maintenance,

- i) "Twin Manufacturing" by MTAB
- ii)" Industrial Robotics and Automation" by MTAB
- iii) "Self Reliance in military & civil Aviation Maintenance"



**Lokmanya Tilak Jankalyan Shikshan Sanstha's
PRIYADARSHINI COLLEGE OF ENGINEERING**

(Recognised by A.I.C.T.E., New Delhi & Govt. of Maharashtra, Affiliated to R.T.M.Nagpur University)
Near CRPF Campus, Hingna Road, Nagpur-440 019, Maharashtra (India)
Phone : 07104 - 236381, 237307, Fax : 07104 - 237681,
email : principal.pce.ngp@gmail.com, www.pcenagpur.edu.in



**LokmanyaTilakJankalyanShikshanSanstha's
PRIYADARSHINI COLLEGE OF ENGINEERING**
Priyadarshini Campus, Digdoh Hills, Hingna Road, Nagpur-440019
www.pcenagpur.edu.in

Series on Manufacturing and Maintenance

Details of Session

Session 1

Title of Webinar:- "Twin Manufacturing" by MTAB

Eminent Speaker:- Mr. Arvind Ramachandra, Sr. Sales Executive, by MTAB Chennai

Session 2

Title of Webinar:- "Industrial Robotics and Automation" by MTAB

Eminent Speaker:- Dr. K.S.Zakiuddin,PCE Nagpur

Session 3

Title of Webinar:- "Self Reliance in military & civil Aviation Maintenance"

Eminent Speaker:- Grp.Cpt. K.S.Mathur (Rtd. IAF)



**Lokmanya Tilak Jankalyan Shikshan Sanstha's
PRIYADARSHINI COLLEGE OF ENGINEERING**

(Recognised by A.I.C.T.E., New Delhi & Govt. of Maharashtra, Affiliated to R.T.M.Nagpur University)
Near CRPF Campus, Hingna Road, Nagpur-440 019, Maharashtra (India)
Phone : 07104 - 236381, 237307, Fax : 07104 - 237681,
email : principal.pce.ngp@gmail.com, www.pcenagpur.edu.in



i) Two days STTP on "Twin Manufacturing" by MTAB



**PRIYADARSHINI COLLEGE OF ENGINEERING
MECHANICAL ENGINEERING DEPARTMENT**



Faculty Development Program on Digital Twin Manufacturing

Date: 18/06/2018 to 19/06/2018

Speakers:

**Mr. Arvind Ramachandran, Sr. Sales Executive, MTAB Chennai
&
Mr. Sathya seelan Sales Engineer, MTAB Chennai**

**Convener
Prof. H. K. Dubey**

**Co-Convener
Mr. S. P. Lokhande**

**Coordinator
Prof. S. Shelare**

**Coordinator
Prof. Chetan Tembhurkar**

**All Interested Participants shall register on or before 16/06/2018 at the
following link: <https://forms.gle/1rNK2iffF37mwoive8>**



**Lokmanya Tilak Jankalyan Shikshan Sanstha's
PRIYADARSHINI COLLEGE OF ENGINEERING**

(Recognised by A.I.C.T.E., New Delhi & Govt. of Maharashtra, Affiliated to R.T.M.Nagpur University)
Near CRPF Campus, Hingna Road, Nagpur-440 019, Maharashtra (India)
Phone : 07104 - 236381, 237307, Fax : 07104 - 237681,
email : principal.pce.ngp@gmail.com, www.pcenagpur.edu.in



STTP on Digital Twin Manufacturing (18/06/2018 to 19/06/2018)

Form description

Name *

Short answer text

Email.id *

Short answer text

Designation & Name of the Institute *



Activat



Lokmanya Tilak Jankalyan Shikshan Sanstha's
PRIYADARSHINI COLLEGE OF ENGINEERING

(Recognised by A.I.C.T.E., New Delhi & Govt. of Maharashtra, Affiliated to R.T.M.Nagpur University)
Near CRPF Campus, Hingna Road, Nagpur-440 019, Maharashtra (India)
Phone : 07104 - 236381, 237307, Fax : 07104 - 237681,
email : principal.pce.ngp@gmail.com, www.pcenagpur.edu.in



STTP on Digital Twin Manufacturing

Sr. No	Name	Designation & Name of the Institute
1	Dr. K. S. Zakiuddin	HOD, Priyadarshini College of Engineering
2	Dr. I. A. Khan	Associate Professor, Priyadarshini College of Engineering
3	Dr. C. N. Sakhale	Associate Professor, Priyadarshini College of Engineering
4	Dr. M. S. Giripunje	Assistant Professor, Priyadarshini College of Engineering
5	Dr. P. S. Chaudhari	Assistant Professor, Priyadarshini College of Engineering
6	Prof. N. R. Pathare	Assistant Professor, Priyadarshini College of Engineering
7	Prof. P. B. Khope	Assistant Professor, Priyadarshini College of Engineering
8	Prof. S. B. Jawlekar	Assistant Professor, Priyadarshini College of Engineering
9	Prof. R. S. Tupkar	Assistant Professor, Priyadarshini College of Engineering
10	Prof. H. K. Dubey	Assistant Professor, Priyadarshini College of Engineering
11	Prof. S. V. Sontakke	Assistant Professor, Priyadarshini College of Engineering
12	Prof. S. P. Lokhande	Assistant Professor, Priyadarshini College of Engineering
13	Prof. C. K. Tembhurkar	Assistant Professor, Priyadarshini College of Engineering
14	Prof. V. S. Shende	Assistant Professor, Priyadarshini College of Engineering
15	Prof. M. S. Matey	Assistant Professor, Priyadarshini College of Engineering



**Lokmanya Tilak Jankalyan Shikshan Sanstha's
PRIYADARSHINI COLLEGE OF ENGINEERING**

(Recognised by A.I.C.T.E., New Delhi & Govt. of Maharashtra, Affiliated to R.T.M.Nagpur University)
Near CRPF Campus, Hingna Road, Nagpur-440 019, Maharashtra (India)
Phone : 07104 - 236381, 237307, Fax : 07104 - 237681,
email : principal.pce.ngp@gmail.com, www.pcenagpur.edu.in





**Lokmanya Tilak Jankalyan Shikshan Sanstha's
PRIYADARSHINI COLLEGE OF ENGINEERING**

(Recognised by A.I.C.T.E., New Delhi & Govt. of Maharashtra, Affiliated to R.T.M.Nagpur University)
Near CRPF Campus, Hingna Road, Nagpur-440 019, Maharashtra (India)
Phone : 07104 - 236381, 237307, Fax : 07104 - 237681,
email : principal.pce.ngp@gmail.com, www.pcenagpur.edu.in



ii) Two days STTP on " Industrial Robotics and Automation" by MTAB

**Priyadarshini College of Engineering,
Nagpur**

**STTP on "Industrial Robotics
and Automation"**



(26-09-2018 to 27-09-2018)

Convener

Dr. K. S. Zakiruddin
Prof. & H.O.D. Mechanical Engg.

Co - Convener
Dr. I. A. Khan



Organized by:

DEPARTMENT OF MECHANICAL ENGINEERING
PRIYADARSHINI COLLEGE OF ENGINEERING
Near CRPF Campus, Hingna Road, M.I.D.C.,
Nagpur - 440019 (M. S.) INDIA.
Tel. : +917104 - 236381, 236179, 236048
Fax : 237681
Website : www.pcenagpur.edu.in

Priyadarshini College of Engineering, Nagpur

**STTP on "Industrial Robotics and
Automation"**

(26-September-2018 to 27-September-2018)
REGISTRATION FORM

- 1) Name: _____
 - 2) Age: _____
 - 3) Designation: _____
 - 4) Institute/Industry: _____
 - 5) Mailing Address: _____

 - 6) Contact Nos. _____
 - 7) Email ID: _____
 - 8) Qualification: _____
 - 9) Experience (Teaching/Industry): _____
- I agree to abide by rules and regulations governing the above workshop.



Lokmanya Tilak Jankalyan Shikshan Sanstha's
PRIYADARSHINI COLLEGE OF ENGINEERING

(Recognised by A.I.C.T.E., New Delhi & Govt. of Maharashtra, Affiliated to R.T.M.Nagpur University)
Near CRPF Campus, Hingna Road, Nagpur-440 019, Maharashtra (India)
Phone : 07104 - 236381, 237307, Fax : 07104 - 237681,
email : principal.pce.ngp@gmail.com, www.pcenagpur.edu.in



STTP on Industrial Robotics and Automation

Sr. No	Name	Designation & Name of the Institute
1	Dr. K. S. Zakiuddin	HOD, Priyadarshini College of Engineering
2	Dr. I. A. Khan	Associate Professor, Priyadarshini College of Engineering
3	Dr. C. N. Sakhale	Associate Professor, Priyadarshini College of Engineering
4	Dr. M. S. Giripunje	Assistant Professor, Priyadarshini College of Engineering
5	Prof. P. B. Khope	Assistant Professor, Priyadarshini College of Engineering
6	Prof. S. B. Jawlekar	Assistant Professor, Priyadarshini College of Engineering
7	Prof. R. S. Tupkar	Assistant Professor, Priyadarshini College of Engineering
8	Prof. H. K. Dubey	Assistant Professor, Priyadarshini College of Engineering
9	Prof. S. V. Sontakke	Assistant Professor, Priyadarshini College of Engineering
10	Prof. S. P. Lokhande	Assistant Professor, Priyadarshini College of Engineering
11	Prof. C. K. Tembhurkar	Assistant Professor, Priyadarshini College of Engineering
12	Prof. V. S. Shende	Assistant Professor, Priyadarshini College of Engineering



**Lokmanya Tilak Jankalyan Shikshan Sanstha's
PRIYADARSHINI COLLEGE OF ENGINEERING**

(Recognised by A.I.C.T.E., New Delhi & Govt. of Maharashtra, Affiliated to R.T.M.Nagpur University)
Near CRPF Campus, Hingna Road, Nagpur-440 019, Maharashtra (India)
Phone : 07104 - 236381, 237307, Fax : 07104 - 237681,
email : principal.pce.ngp@gmail.com, www.pcenagpur.edu.in



Priyadarshini College of Engineering

CERTIFICATE

This certificate declares that

Prof. S. V. Sontakke

has completed

**STTP On Industrial Robotics & Automation
Organized By
Department of Mechanical Engineering
from 26/09/2018 To 27/09/2018**

**Dr. K. S. Zakiuddin
HOD, ME**

**Dr. M. P. Singh
Principal, PCE**



**Lokmanya Tilak Jankalyan Shikshan Sanstha's
PRIYADARSHINI COLLEGE OF ENGINEERING**

(Recognised by A.I.C.T.E., New Delhi & Govt. of Maharashtra, Affiliated to R.T.M.Nagpur University)
Near CRPF Campus, Hingna Road, Nagpur-440 019, Maharashtra (India)
Phone : 07104 - 236381, 237307, Fax : 07104 - 237681,
email : principal.pce.ngp@gmail.com, www.pcenagpur.edu.in



iii) Two days National Level Symposium on “Self Reliance in military & civil Aviation Maintenance”.

One Page Report

Department Organized: Department of Aeronautical Engineering.

Participated by: Students and Faculty Members from various Departments and Organizations.

Venue: Seminar Hall, Training and Placement, Mechanical Building, PCE Campus, Nagpur.

Date: 12th and 13th March 2019

TIME: Full Day.

Event: “Two days National Symposium” in two sessions with session title “Self Reliance in military & civil Aviation Maintenance”

By:

1. Grp.Cpt. K.S.Mathur (Rtd. IAF)
2. Dr. Chandras C.Handa (KDK, Nagpur)
3. Mr.S.R.Pimple (Ex. General Manager, Ashoke Layland, Bhandara)
4. Mr.B.Jena (Deputy General Manager, Air India MRO, MIHAN, Nagpur)
5. Grp.Cpt.N.Karthikeyan (IAF, Headquarter MC, Nagpur)
6. Air Vice Marshal S.Chaoji (IAF, Headquarter MC, Nagpur)

Co-Ordinators : 1. Prof.P.Tembhare, CT, Dept. PCE, Nagpur.
2. Prof.S.Tiwari, Mathematics Dept., PCE, Nagpur.

Purpose: For today's advancement and applications of MRO Industry in self reliance in military & civil aviation maintenance a collaborative initiative is taken by the academicians and Industry person for mutual understanding and recent developments towards indigenization.

Dignitaries from PCE: Dr. J.P.Modak, Dr. M.P.Singh, Dr. S.A.Dhale, HoD's of all departments. Dr. M Dixit, Mr. A. Mothgare, Mr. K Sawade.

Faculties from Aeronautical Engg. Dept. : Dr. G.D.Mehta, Prof. Manoj Mahore, Prof. Sandeep Patil, Prof. D.Raut, Prof. Jhumki Nandy, Prof. Vishal Kaushik, Prof. P. Neelima, Prof. A.Sharma.



Lokmanya Tilak Jankalyan Shikshan Sanstha's
PRIYADARSHINI COLLEGE OF ENGINEERING

(Recognised by A.I.C.T.E., New Delhi & Govt. of Maharashtra, Affiliated to R.T.M.Nagpur University)
Near CRPF Campus, Hingna Road, Nagpur-440 019, Maharashtra (India)
Phone : 07104 - 236381, 237307, Fax : 07104 - 237681,
email : principal.pce.ngp@gmail.com, www.pcenagpur.edu.in



16.Training program for supporting staff on "Introduction to Pelton Turbine"(HM Lab)

Department Organized : MECHANICAL DEPARTMENT.

Participated By: - Supporting staff of Dept. Of Mechanical Engineering.

Venue: - Hydraulic Machines Laboratory of Mechanical Department.

Event: Introduction to Pelton Turbine ”

Resource Person: Prof.S.P.Lokhande

Date: 29/12/2018

No of Participant :08

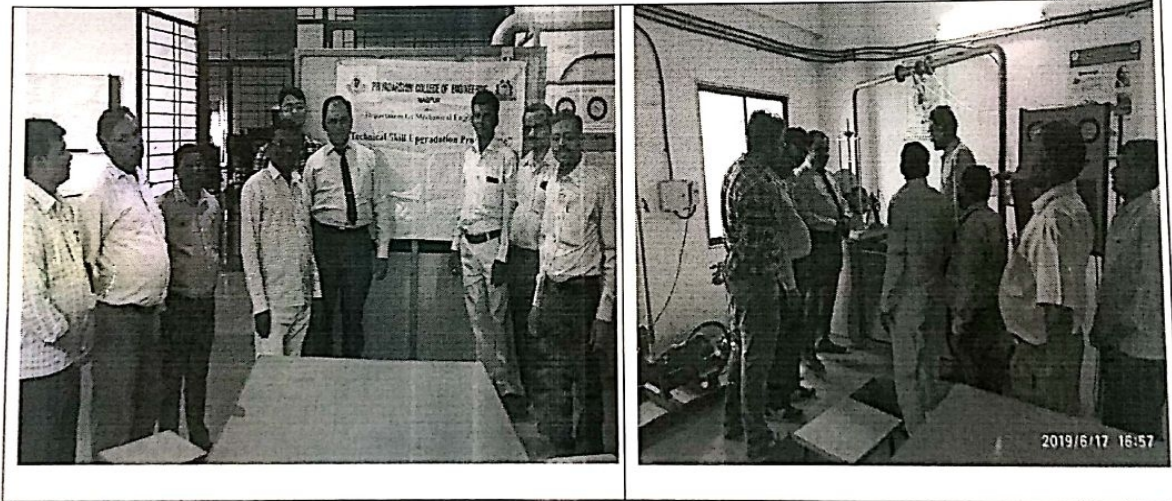

Remark/Conclusion: Prof.S.P.Lokhande introduce the pelton turbine in HM Lab and also explain its Working to the supporting staff.



Lokmanya Tilak Jankalyan Shikshan Sanstha's
PRIYADARSHINI COLLEGE OF ENGINEERING

(Recognised by A.I.C.T.E., New Delhi & Govt. of Maharashtra, Affiliated to R.T.M.Nagpur University)
Near CRPF Campus, Hingna Road, Nagpur-440 019, Maharashtra (India)
Phone : 07104 - 236381, 237307, Fax : 07104 - 237681,
email : principal.pce.ngp@gmail.com, www.pcenagpur.edu.in



17. Training program for supporting staff on "Torsion Testing Machine" (MOM Lab)

Department Organized : MECHANICAL DEPARTMENT.

Participated By: - Supporting staff of Dept. Of Mechanical Engineering.

Venue: - Mechanics of Material Laboratory of Mechanical Department.

Event: Introduction to Torsion Testing Machine ”

Resource Person: Prof.A.D.Meshram

Date: 27/04/2019

No of Participant :08



Remark/Conclusion: Prof.A.D.Meshram introduce the Torsion Testing Machine and its working in MOM Lab to supporting staff.



**Lokmanya Tilak Jankalyan Shikshan Sanstha's
PRIYADARSHINI COLLEGE OF ENGINEERING**

(Recognised by A.I.C.T.E., New Delhi & Govt. of Maharashtra, Affiliated to R.T.M.Nagpur University)
Near CRPF Campus, Hingna Road, Nagpur-440 019, Maharashtra (India)
Phone : 07104 - 236381, 237307, Fax : 07104 - 237681,
email : principal.pce.ngp@gmail.com, www.pcenagpur.edu.in



18. Two days FDP on "Quest for Best".

Priyadarshini College of Engineering
Mechanical Engineering Department
Under
Priyadarshani Center of Excellence

QUEST FOR THE BEST

Road to Excellence

Road to Excellence

Faculty Development Programme - 2018 - 19



Lokmanya Tilak Jankalyan Shikshan Sanstha's
PRIYADARSHINI COLLEGE OF ENGINEERING

(Recognised by A.I.C.T.E., New Delhi & Govt. of Maharashtra, Affiliated to R.T.M.Nagpur University)
Near CRPF Campus, Hingna Road, Nagpur-440 019, Maharashtra (India)
Phone : 07104 - 236381, 237307, Fax : 07104 - 237681,
email : principal.pce.ngp@gmail.com, www.pcenagpur.edu.in



Quest for Best

Sr. No	Name	Designation & Name of the Institute
1	Dr. K. S. Zakiuddin	HOD, Priyadarshini College of Engineering
2	Dr. I. A. Khan	Associate Professor, Priyadarshini College of Engineering
3	Dr. C. N. Sakhale	Associate Professor, Priyadarshini College of Engineering
4	Dr. M. S. Giripunje	Assistant Professor, Priyadarshini College of Engineering
5	Dr. P. S. Chaudhari	Assistant Professor, Priyadarshini College of Engineering
6	Prof. N. R. Pathare	Assistant Professor, Priyadarshini College of Engineering
7	Prof. P. B. Khope	Assistant Professor, Priyadarshini College of Engineering
8	Prof. Wasim Sheikh	Assistant Professor, Priyadarshini College of Engineering
9	Prof. Nakul Mahalle	Assistant Professor, Priyadarshini College of Engineering
10	Prof. N. S. Sawarkar	Assistant Professor, Priyadarshini College of Engineering
11	Prof. D. M. Hajare	Assistant Professor, Priyadarshini College of Engineering
12	Prof. Rizwan Farooqui	Assistant Professor, Priyadarshini College of Engineering
13	Prof. G. T. Dhanuskar	Assistant Professor, Priyadarshini College of Engineering
14	Prof. A. S. Nilewar	Assistant Professor, Priyadarshini College of Engineering
15	Prof. L. D. Gabhane	Assistant Professor, Priyadarshini College of Engineering
16	Prof. S. B. Jawlekar	Assistant Professor, Priyadarshini College of Engineering
17	Prof. R. S. Tupkar	Assistant Professor, Priyadarshini College of Engineering
18	Prof. H. K. Dubey	Assistant Professor, Priyadarshini College of Engineering
19	Prof. S. V. Sontakke	Assistant Professor, Priyadarshini College of Engineering
20	Prof. S. P. Lokhande	Assistant Professor, Priyadarshini College of Engineering
21	Prof. P. P. Shirpurkar	Assistant Professor, Priyadarshini College of Engineering
22	Prof. C. K. Tembhurkar	Assistant Professor, Priyadarshini College of Engineering
23	Prof. P. Borkar	Assistant Professor, Priyadarshini College of Engineering
24	Prof. V. S. Shende	Assistant Professor, Priyadarshini College of Engineering
25	Prof. M. S. Matey	Assistant Professor, Priyadarshini College of Engineering
26	Prof. S.S. Dongre	Assistant Professor, Priyadarshini College of Engineering
27	Prof. A. Adhaye	Assistant Professor, Priyadarshini College of Engineering
28	Prof. D. K. Padhal	Assistant Professor, Priyadarshini College of Engineering
29	Prof. S. G. Ughade	Assistant Professor, Priyadarshini College of Engineering



**Lokmanya Tilak Jankalyan Shikshan Sanstha's
PRIYADARSHINI COLLEGE OF ENGINEERING**

(Recognised by A.I.C.T.E., New Delhi & Govt. of Maharashtra, Affiliated to R.T.M.Nagpur University)
Near CRPF Campus, Hingna Road, Nagpur-440 019, Maharashtra (India)
Phone : 07104 - 236381, 237307, Fax : 07104 - 237681,
email : principal.pce.ngp@gmail.com, www.pcenagpur.edu.in





**Lokmanya Tilak Jankalyan Shikshan Sanstha's
PRIYADARSHINI COLLEGE OF ENGINEERING**

(Recognised by A.I.C.T.E., New Delhi & Govt. of Maharashtra, Affiliated to R.T.M.Nagpur University)
Near CRPF Campus, Hingna Road, Nagpur-440 019, Maharashtra (India)
Phone : 07104 - 236381, 237307, Fax : 07104 - 237681,
email : principal.pce.ngp@gmail.com, www.pcenagpur.edu.in



19. Technical series

- i) "Recent Trends in Embedded System and IoT",
- ii) Two days STTP on " Additive Manufacturing",
- iii) Two days STTP on " Solid Modelling using solid works"



Lokmanya Tilak Jankalyan Shikshan Sanstha's
PRIYADARSHINI COLLEGE OF ENGINEERING

(Recognised by A.I.C.T.E., New Delhi & Govt. of Maharashtra, Affiliated to R.T.M.Nagpur University)
Near CRPF Campus, Hingna Road, Nagpur-440 019, Maharashtra (India)
Phone : 07104 - 236381, 237307, Fax : 07104 - 237681,
email : principal.pce.ngp@gmail.com, www.pcenagpur.edu.in



Lokmanya Tilak Jankalyan Shikshan Sanstha's
PRIYADARSHINI COLLEGE OF ENGINEERING
Priyadarshini Campus, Digidoh Hills, Hingna Road, Nagpur-440019
www.pcenagpur.edu.in

Technical series
Details of Session

Session 1

Title of Webinar:- "Recent Trends in Embedded System and IoT"

Invited Speaker:- Dr. R.M.Patrikar, VNIT Nagpur

Session 2

Title of Webinar:- "Two days STTP on " Additive Manufacturing",

Invited Speaker:- Mr. Rajat Kawalkar, Uppsala University, Sweden

Mr. Akhilesh Sontakke, Achen university, Germany

Session 3

Title of Webinar:- Two days STTP on " Solid Modelling using solid works

Invited Speaker:- Mr. Anand Nilewar,PCE Nagpur

Mr. Mohit Dubey,CADD Center Nagpur.



Lokmanya Tilak Jankalyan Shikshan Sanstha's
PRIYADARSHINI COLLEGE OF ENGINEERING

(Recognised by A.I.C.T.E., New Delhi & Govt. of Maharashtra, Affiliated to R.T.M.Nagpur University)
Near CRPF Campus, Hingna Road, Nagpur-440 019, Maharashtra (India)
Phone : 07104 - 236381, 237307, Fax : 07104 - 237681,
email : principal.pce.ngp@gmail.com, www.pcenagpur.edu.in



i)Two days Workshop on “Recent Trends in Embedded System and IoT”.

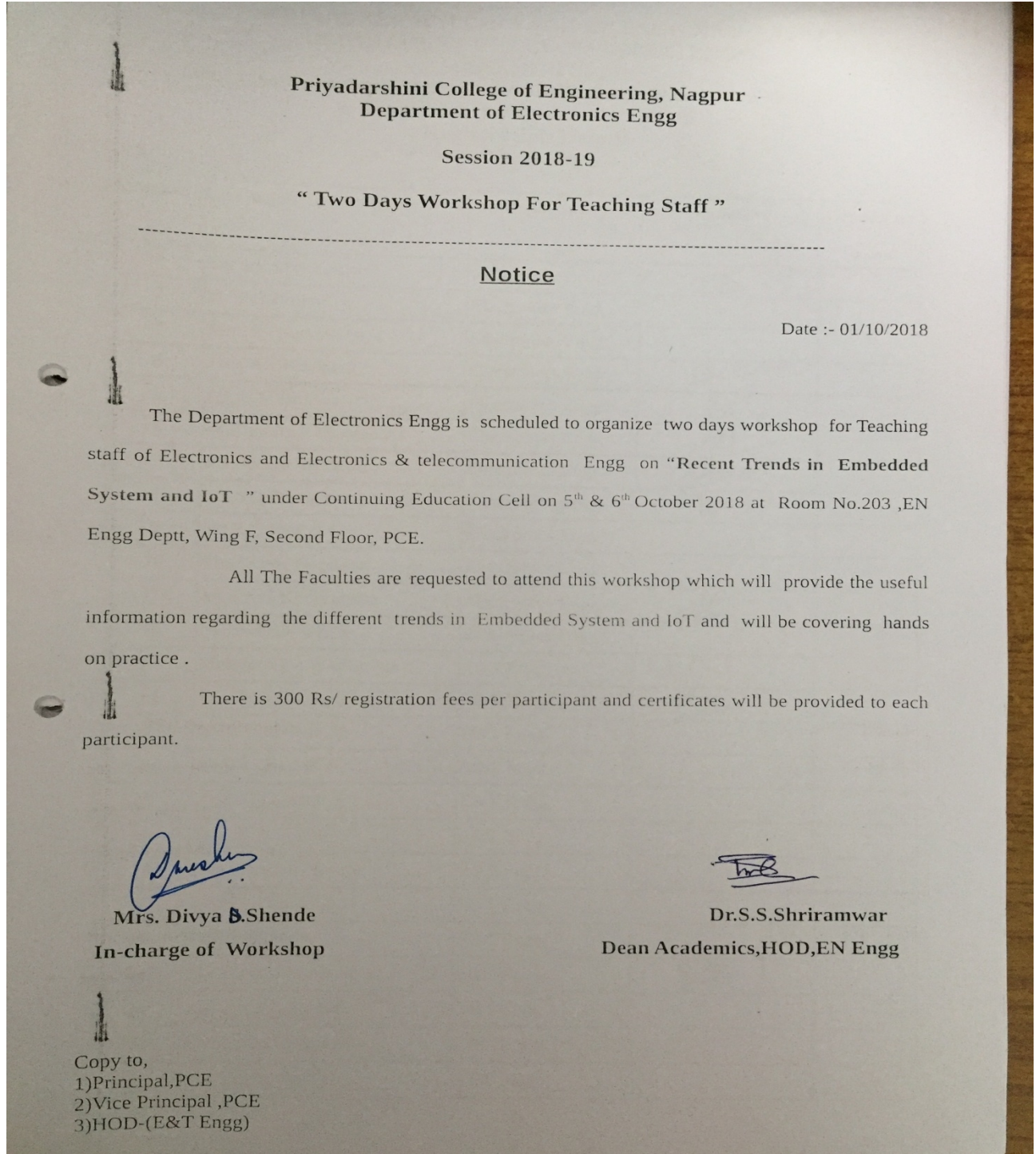



Lokmanya Tilak Jankalyan Shikshan Sanstha's
PRIYADARSHINI COLLEGE OF ENGINEERING

(Recognised by A.I.C.T.E., New Delhi & Govt. of Maharashtra, Affiliated to R.T.M.Nagpur University)
Near CRPF Campus, Hingna Road, Nagpur-440 019, Maharashtra (India)
Phone : 07104 - 236381, 237307, Fax : 07104 - 237681,
email : principal.pce.ngp@gmail.com, www.pcenagpur.edu.in



PRIYADARSHINI COLLEGE OF ENGG,NAGPUR
DEPARTMENT OF ELECTRONICS ENGG
SESSION 2018-19

Two days Workshop on "Recent Trends in Embedded System and IoT"
Under Continuing Education Cell

Registration Details
5th & 6th October 2018

Sr.No.	Name of Candidate	Department	Signature	Certificate Issued
1	Dr. S.S.Shriramwar	Electronics Engg		
2	Dr. P.R.Rothe	Electronics Engg		
3	Mrs. P.J.Suryawanshi	Electronics Engg		
4	Mrs. A.P.Khandait	Electronics Engg		
5	Mr. C.N.Bhojar	Electronics Engg		
6	Dr.Mrs. M.V.Vyawahare	Electronics Engg		
7	Ms. Divya Meshram	Electronics Engg		
8	Ms.S.G.Mungle	Electronics Engg		
9	Mr.R.C.Iyer	Electronics Engg		
10	Mrs. K.M. Bogawar	Electronics Engg		
11	Mrs. A.S.Khobragade	Electronics Engg		
12	Ms.Swheta Sarode	Electronics Engg		
13	Mrs.Surekha Washimkar	E&T Engg		
14	Mrs.Jaya Bhattad	E&T Engg		
15	Mr.Manoj demade	E&T Engg		
16	Mr.O.G.Hastak	E&T Engg		
17	Mr.D.G.Gahane	E&T Engg		
18	Dr.A.B.Jirapure	E&T Engg		
19	Mrs.Vrushali Nasare	E&T Engg		
20	Mr.Nitin Aambatkar	E&T Engg		
21	Mr.V.Giripunje	E&T Engg		
22	Ms.Sheetal Mungale	E&T Engg		
23	Ms.Deepali Sukhdeve	E&T Engg		
24	Ms.Pajkta Upadhye	E&T Engg		
25	Mrs Prachi Pendake	E&T Engg		



**Lokmanya Tilak Jankalyan Shikshan Sanstha's
PRIYADARSHINI COLLEGE OF ENGINEERING**

(Recognised by A.I.C.T.E., New Delhi & Govt. of Maharashtra, Affiliated to R.T.M.Nagpur University)
Near CRPF Campus, Hingna Road, Nagpur-440 019, Maharashtra (India)
Phone : 07104 - 236381, 237307, Fax : 07104 - 237681,
email : principal.pce.ngp@gmail.com, www.pcenagpur.edu.in



ii) Two days STTP on " Additive Manufacturing "



 **PRIYADARSHINI COLLEGE OF ENGINEERING
MECHANICAL ENGINEERING DEPARTMENT** 

Short Term Training Program on Additive Manufacturing

Date: 20/02/2019 to 21/02/2019

Speakers:

**Mr. Rajat Kawalkar , Uppsala, University, Sweden
Mr. Akhilesh Sontakke, Achen University, Germany**

Convener
Dr. I. A. Khan
Associate Professor, Mechanical Engg.

Co-Convener
Prof. H. K. Dubey

Coordinator
Prof. S. P. Lokhande

Coordinator
Prof. Sagar Shelare

All Interested Participants shall register on or before 19/02/2019 at the following link: <https://forms.gle/hepuYFomKxXahkDG8>



**Lokmanya Tilak Jankalyan Shikshan Sanstha's
PRIYADARSHINI COLLEGE OF ENGINEERING**

(Recognised by A.I.C.T.E., New Delhi & Govt. of Maharashtra, Affiliated to R.T.M.Nagpur University)
Near CRPF Campus, Hingna Road, Nagpur-440 019, Maharashtra (India)
Phone : 07104 - 236381, 237307, Fax : 07104 - 237681,
email : principal.pce.ngp@gmail.com, www.pcenagpur.edu.in



STTP on " Additive Manufacturing"(20/02/2019 to 21/02/2019)

Form description

Name *

Short answer text

Email.id *

Short answer text

Designation & Name of the Institute *

Activate V
Go to Settings



Lokmanya Tilak Jankalyan Shikshan Sanstha's
PRIYADARSHINI COLLEGE OF ENGINEERING

(Recognised by A.I.C.T.E., New Delhi & Govt. of Maharashtra, Affiliated to R.T.M.Nagpur University)
Near CRPF Campus, Hingna Road, Nagpur-440 019, Maharashtra (India)
Phone : 07104 - 236381, 237307, Fax : 07104 - 237681,
email : principal.pce.ngp@gmail.com, www.pcenagpur.edu.in



STTP on Additive Manufacturing

Sr. No	Name	Designation & Name of the Institute
1	Dr. K. S. Zakiuddin	HOD, Priyadarshini College of Engineering
2	Dr. I. A. Khan	Associate Professor, Priyadarshini College of Engineering
3	Dr. C. N. Sakhale	Associate Professor, Priyadarshini College of Engineering
4	Dr. M. S. Giripunje	Assistant Professor, Priyadarshini College of Engineering
5	Prof. Anand Nilewar	Assistant Professor, Priyadarshini College of Engineering
6	Prof. P. B. Khope	Assistant Professor, Priyadarshini College of Engineering
7	Prof. H. K. Dubey	Assistant Professor, Priyadarshini College of Engineering
8	Prof. S. V. Sontakke	Assistant Professor, Priyadarshini College of Engineering
9	Prof. S. P. Lokhande	Assistant Professor, Priyadarshini College of Engineering
10	Prof. C. K. Tembhurkar	Assistant Professor, Priyadarshini College of Engineering
11	Prof. V. S. Shende	Assistant Professor, Priyadarshini College of Engineering
12	Prof. Sagar Shelare	Assistant Professor, Priyadarshini College of Engineering
13	Prof. R. S. Tupkar	Assistant Professor, Priyadarshini College of Engineering





Lokmanya Tilak Jankalyan Shikshan Sanstha's
PRIYADARSHINI COLLEGE OF ENGINEERING

(Recognised by A.I.C.T.E., New Delhi & Govt. of Maharashtra, Affiliated to R.T.M.Nagpur University)
Near CRPF Campus, Hingna Road, Nagpur-440 019, Maharashtra (India)
Phone : 07104 - 236381, 237307, Fax : 07104 - 237681,
email : principal.pce.ngp@gmail.com, www.pcenagpur.edu.in



Priyadarshini College of Engineering

CERTIFICATE

This certificate declares that

Prof. Anand Nilewar

has completed

The STTP on Additive Manufacturing
Organized By
Department of Mechanical Engineering
From 20/02/2019 To 21/02/2019

Dr. K. S. Zakiuddin
HOD, Mech

Dr. M. P. Singh
Principal, PCE



**Lokmanya Tilak Jankalyan Shikshan Sanstha's
PRIYADARSHINI COLLEGE OF ENGINEERING**

(Recognised by A.I.C.T.E., New Delhi & Govt. of Maharashtra, Affiliated to R.T.M.Nagpur University)
Near CRPF Campus, Hingna Road, Nagpur-440 019, Maharashtra (India)
Phone : 07104 - 236381, 237307, Fax : 07104 - 237681,
email : principal.pce.ngp@gmail.com, www.pcenagpur.edu.in



iii) Two days STTP on " Solid Modelling using solid works"



**PRIYADARSHINI COLLEGE OF ENGINEERING
MECHANICAL ENGINEERING DEPARTMENT**

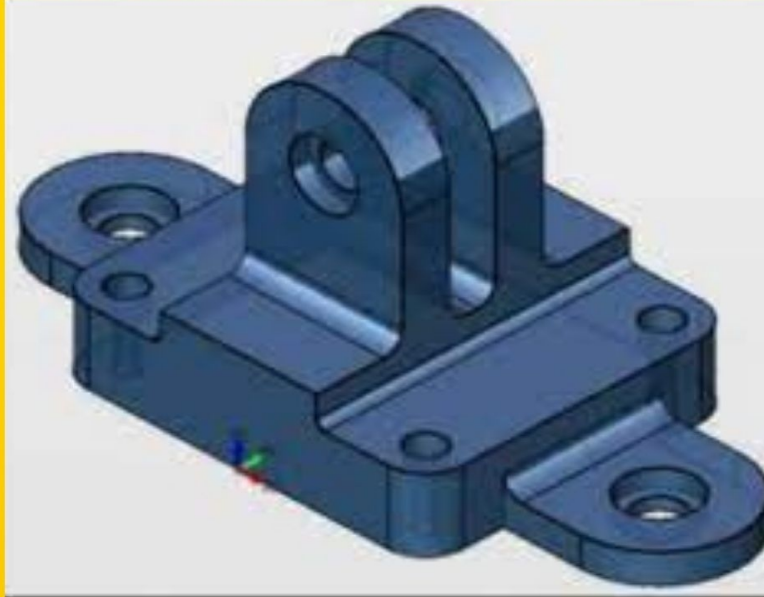

Short Term Training Program on Solid Modelling Using Solid Works

Date: 22/04/2019 to 23/04/2019

Speakers:

**Mr. Anand Nilewar, PCE
Mr. Mohit Dubey, CADD Center Nagpur**

Convener

**Dr. I. A. Khan
Associate Professor, Mechanical Engg.**

**Coordinator
Prof. S. P. Lokhande**

**Coordinator
Prof. Sagar Shelare**

**All Interested Participants shall register on or before 20/04/2019 at the following
link: <https://forms.gle/mdx1ePCvUM9NpYc79>**



**Lokmanya Tilak Jankalyan Shikshan Sanstha's
PRIYADARSHINI COLLEGE OF ENGINEERING**

(Recognised by A.I.C.T.E., New Delhi & Govt. of Maharashtra, Affiliated to R.T.M.Nagpur University)
Near CRPF Campus, Hingna Road, Nagpur-440 019, Maharashtra (India)
Phone : 07104 - 236381, 237307, Fax : 07104 - 237681,
email : principal.pce.ngp@gmail.com, www.pcenagpur.edu.in



STTP on " Solid Modelling using solid works" (22/04/2019 to 23/04/2019)

Form description

Name *

Short answer text

Email.id *

Short answer text

Designation & Name of the Institute *

Short answer text



Activat
Go to Set



**Lokmanya Tilak Jankalyan Shikshan Sanstha's
PRIYADARSHINI COLLEGE OF ENGINEERING**

(Recognised by A.I.C.T.E., New Delhi & Govt. of Maharashtra, Affiliated to R.T.M.Nagpur University)
Near CRPF Campus, Hingna Road, Nagpur-440 019, Maharashtra (India)
Phone : 07104 - 236381, 237307, Fax : 07104 - 237681,
email : principal.pce.ngp@gmail.com, www.pcenagpur.edu.in



STTP on Solid Modelling Using Solid Works

Sr. No	Name	Designation & Name of the Institute
1	Dr. K. S. Zakiuddin	HOD, Priyadarshini College of Engineering
2	Dr. I. A. Khan	Associate Professor, Priyadarshini College of Engineering
3	Dr. C. N. Sakhale	Associate Professor, Priyadarshini College of Engineering
4	Dr. M. S. Giripunje	Assistant Professor, Priyadarshini College of Engineering
5	Dr. P. S. Chaudhari	Assistant Professor, Priyadarshini College of Engineering
6	Prof. N. R. Pathare	Assistant Professor, Priyadarshini College of Engineering
7	Prof. P. B. Khope	Assistant Professor, Priyadarshini College of Engineering
8	Prof. Wasim Sheikh	Assistant Professor, Priyadarshini College of Engineering
9	Prof. Nakul Mahalle	Assistant Professor, Priyadarshini College of Engineering
10	Prof. A. S. Nilewar	Assistant Professor, Priyadarshini College of Engineering
11	Prof. S. B. Jawlekar	Assistant Professor, Priyadarshini College of Engineering
12	Prof. R. S. Tupkar	Assistant Professor, Priyadarshini College of Engineering
13	Prof. H. K. Dubey	Assistant Professor, Priyadarshini College of Engineering
14	Prof. S. V. Sontakke	Assistant Professor, Priyadarshini College of Engineering
15	Prof. S. P. Lokhande	Assistant Professor, Priyadarshini College of Engineering
16	Prof. P. P. Shirpurkar	Assistant Professor, Priyadarshini College of Engineering
17	Prof. C. K. Tembhurkar	Assistant Professor, Priyadarshini College of Engineering
18	Prof. P. Borkar	Assistant Professor, Priyadarshini College of Engineering
19	Prof. V. S. Shende	Assistant Professor, Priyadarshini College of Engineering
20	Prof. M. S. Matey	Assistant Professor, Priyadarshini College of Engineering





Lokmanya Tilak Jankalyan Shikshan Sanstha's
PRIYADARSHINI COLLEGE OF ENGINEERING

(Recognised by A.I.C.T.E., New Delhi & Govt. of Maharashtra, Affiliated to R.T.M.Nagpur University)
Near CRPF Campus, Hingna Road, Nagpur-440 019, Maharashtra (India)
Phone : 07104 - 236381, 237307, Fax : 07104 - 237681,
email : principal.pce.ngp@gmail.com, www.pcenagpur.edu.in



20. One day workshop on “Different Types of Patents & their uses”.

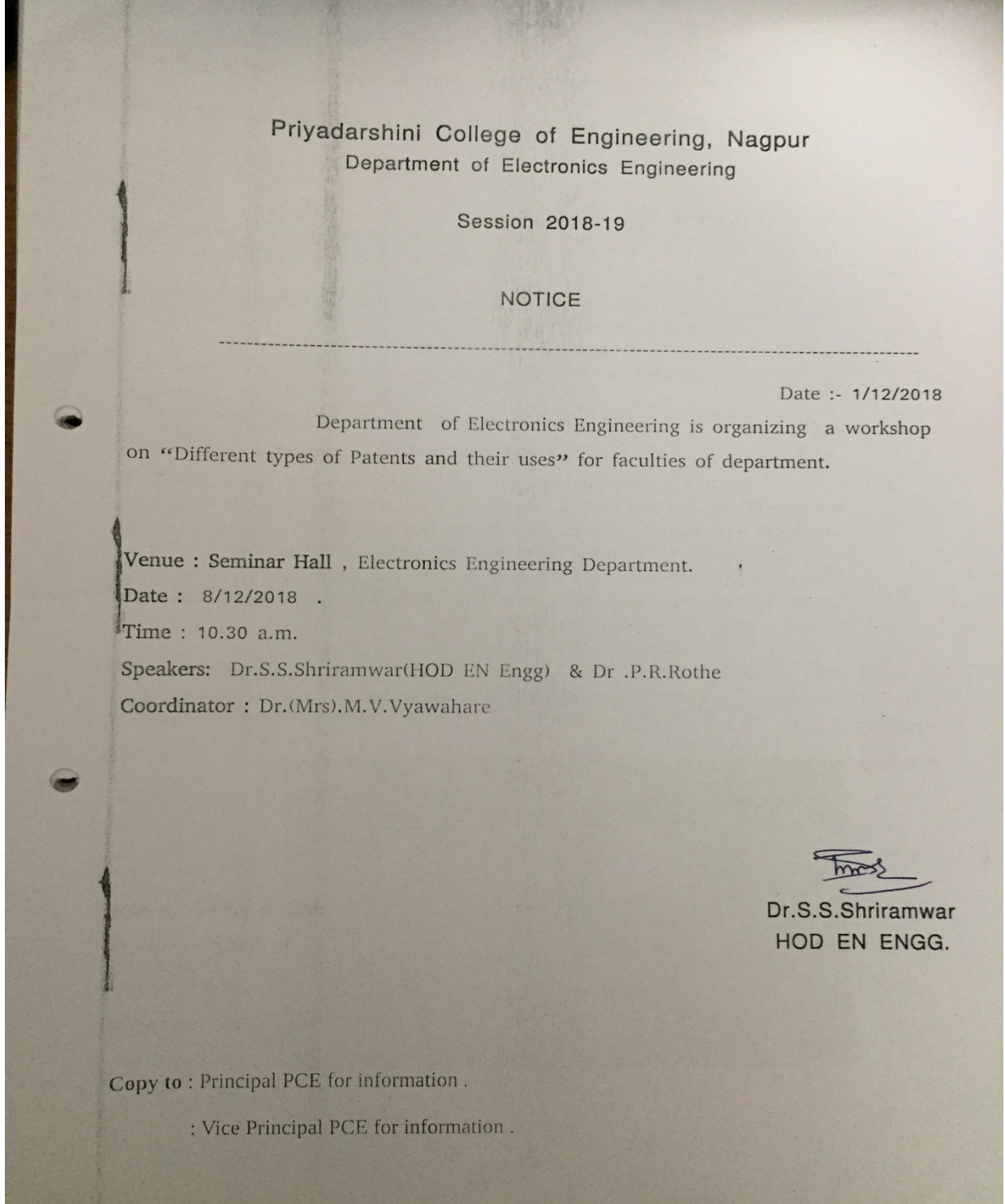



Lokmanya Tilak Jankalyan Shikshan Sanstha's
PRIYADARSHINI COLLEGE OF ENGINEERING

(Recognised by A.I.C.T.E., New Delhi & Govt. of Maharashtra, Affiliated to R.T.M.Nagpur University)
Near CRPF Campus, Hingna Road, Nagpur-440 019, Maharashtra (India)
Phone : 07104 - 236381, 237307, Fax : 07104 - 237681,
email : principal.pce.ngp@gmail.com, www.pcenagpur.edu.in



NAME OF EVENT:-One day Workshop on“Different types of Patents and their uses”

NAME OF DEPARTMENT : Electronics Engineering

DATE OF EVENT : 08-12-2018

OBJECTIVE:- The objective of this workshop was to make aware to the faculty of Engineering profession about different types of Patents and their uses.

EVENT FACULTY INCHARGE: Dr.(Mrs).M.V.Vyawahare

NAME OF Speakers :

1. Dr.S.S.Shriramwar(HOD Engg)
Topic: Different types of Patents
2. Dr.P.R.Rothe, Assit .Prof
Topic : Patents and their uses

NO. OF PARTICIPANTS: 10 faculties from PCE ,EN Dept

REMARK: A One day Workshop on Different types of Patents and their uses” was organized by the Department of Electronics . The faculties from Electronics department of PCE Nagpur had participated . The evnt was very successful. Dr. M.P.Singh ,Principal, PCE, Dr.J.P.Modak ,Dean R &D,Dr.S.S. Shriramwar, HOD, Department of Electronics Engineering, Dr.P.R.Rothe ,Asstt Prof, Department of Electronics Engineering and all the Faculty of Electronics deptt were present .,

CONCLUSION: In this Event, faculties shared their knowledge ,clear their doubt and expressed their views by asking various questions to experts and came to know about different areas of reserch.

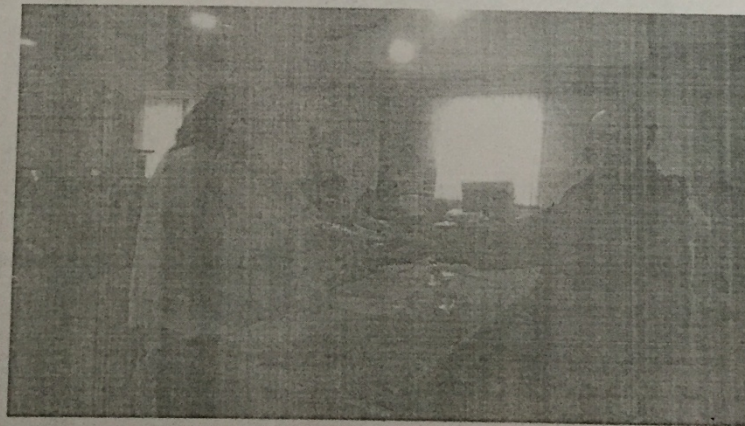

[Handwritten signature]



Lokmanya Tilak Jankalyan Shikshan Sanstha's
PRIYADARSHINI COLLEGE OF ENGINEERING

(Recognised by A.I.C.T.E., New Delhi & Govt. of Maharashtra, Affiliated to R.T.M.Nagpur University)
Near CRPF Campus, Hingna Road, Nagpur-440 019, Maharashtra (India)
Phone : 07104 - 236381, 237307, Fax : 07104 - 237681,
email : principal.pce.ngp@gmail.com, www.pcenagpur.edu.in



Priyadarshini College of Engineering, Nagpur
Department of Electronics Engineering

Session 2018-19

Attendance Sheet

Name of Workshop : "Different types of Patents and their uses.

Resource Person : Dr.S.S.Shriramwar (HOD EN Engg) & Dr. P.R.Rothe

Date : 8/12/2018

I & II Session			
Sr. No.	Name of Faculty	Deptt	Signature
1	Dr. S.S.Shriramwar	EN Engg	
2	Dr. P.R.Rothe	EN Engg	
3	Mrs. P.J.Suryawanshi	EN Engg	
4	Mrs. A.P.Khandait	EN Engg	
5	Mr. C.N.Bhojar	EN Engg	
6	Dr. (Mrs.) M.V.Vvawahare	EN Engg	
7	Ms. Divya Meshram	EN Engg	
8	Ms.S.G.Mungle	EN Engg	
9	Mr.R.C.Iyer	EN Engg	
10	Mrs. K.M. Bogawar	EN Engg	Absent
11	Mrs. A.S.Khobragade	EN Engg	
12	Ms.Shweta Sarode	EN Engg	



**Lokmanya Tilak Jankalyan Shikshan Sanstha's
PRIYADARSHINI COLLEGE OF ENGINEERING**

(Recognised by A.I.C.T.E., New Delhi & Govt. of Maharashtra, Affiliated to R.T.M.Nagpur University)
Near CRPF Campus, Hingna Road, Nagpur-440 019, Maharashtra (India)
Phone : 07104 - 236381, 237307, Fax : 07104 - 237681,
email : principal.pce.ngp@gmail.com, www.pcenagpur.edu.in



21. One day workshop on “ Professional motivation and work ethics” for supporting staff.

Priyadarshini College of Engineering, Nagpur
Department of Electronics Engg

Session 2018-19

One Day Workshop For Supporting Staff

Notice

Date :- 15/12/2018

The Department of Electronics Engg is scheduled to organize a one day workshop for supporting staff of the institute on “Professional Motivation and Work Ethics ” under Continuing Education Cell on 22nd December 2018 at 2:00 pm to 5:00 pm at Room No.203 ,EN Engg Deptt, Wing F , Second Floor.

All supporting staff are requested to attend this workshop which will provide the useful information. There is no registration fees and certificates will be provided to each participant.

Mrs.P.J.Suryawanshi

In-charge

Dr.S.S.Shriramwar

Dean Academics, HOD, EN Engg

Copy to,

1)Principal,PCE

2)Vice Principal ,PCE

3)HOD-(APPLIED MATHS/APPLIED CHEMISTRY/APPLIED PHYSICS)/HUMANITIES/
AE/CIVIL/ELECTRICAL/MECH SHIFT 1 & 2 /E&T/CT/IT)



**Lokmanya Tilak Jankalyan Shikshan Sanstha's
PRIYADARSHINI COLLEGE OF ENGINEERING**

(Recognised by A.I.C.T.E., New Delhi & Govt. of Maharashtra, Affiliated to R.T.M.Nagpur University)
Near CRPF Campus, Hingna Road, Nagpur-440 019, Maharashtra (India)
Phone : 07104 - 236381, 237307, Fax : 07104 - 237681,
email : principal.pce.ngp@gmail.com, www.pcenagpur.edu.in



22. One day workshop on “English Speaking” for supporting staff.

**Priyadarshini College of Engineering, Nagpur
Department of Electronics Engg**

Session 2018-19

One Day Workshop For Supporting Staff

Notice

Date :- 21/03/2019

The Department of Electronics Engg is scheduled to organize a one day workshop for **supporting staff of the institute** on “English Speaking ” under Continuing Education Cell on 30th March 2019 from 11:30 a.m to 3:00 pm at Room No.203 ,EN Engg Deptt, Wing F , Second Floor.

All supporting staff are requested to attend this workshop which will provide the useful information. There is no registration fees and certificates will be provided to each participant.

Mrs.P.J.Suryawanshi
In-charge

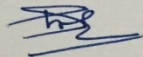
Dr.S.S.Shriramwar
Dean Academics, HOD, EN Engg

Copy to,
1)Principal,PCE
2)Vice Principal ,PCE
3)HOD-(APPLIED MATHS/APPLIED CHEMISTRY/APPLIED PHYSICS)/HUMANITIES/
AE/CIVIL/ELECTRICAL/MECH SHIFT 1 & 2 /E&T/CT/IT)



**Lokmanya Tilak Jankalyan Shikshan Sanstha's
PRIYADARSHINI COLLEGE OF ENGINEERING**

(Recognised by A.I.C.T.E., New Delhi & Govt. of Maharashtra, Affiliated to R.T.M.Nagpur University)
Near CRPF Campus, Hingna Road, Nagpur-440 019, Maharashtra (India)
Phone : 07104 - 236381, 237307, Fax : 07104 - 237681,
email : principal.pce.ngp@gmail.com, www.pcenagpur.edu.in



WORKSHOP: One day Workshop on "English Speaking" on 30th March 2019 .

DEPARTMENT ORGANIZED: Department of Electronics Engineering.

PARTICIPATED BY: Technical Supporting Staff of all Departments of PCE, Nagpur.

PURPOSE: To Educate Technical supporting staff about Work Ethics.

RESOURCE: Dr. Dora Thompson , Astt Prof, Humanities Deptt, PCE, Nagpur .

REMARK: One Day workshop on "English Speaking" was organized by Department of Electronics Engineering on 30th March 2019 .. The workshop was attended by 25 Technical Supporting Staff from all Departments of PCE, Nagpur. The details of Work Ethics were explained by expert. The workshop was very successful. Dr. M.P.Singh ,Principal, PCE, , Dr.S.S. Shriramwar, Dean Academics & HOD, Department of Electronics Engineering, Dr.P.R.Rothe ,Dean Students Council & Asstt Prof, Department of Electronics Engineering Prof. Mrs. P. J. Suryawanshi, In-charge, Continuing Education Cell & One day workshop appreciated the program and all other staff were present.

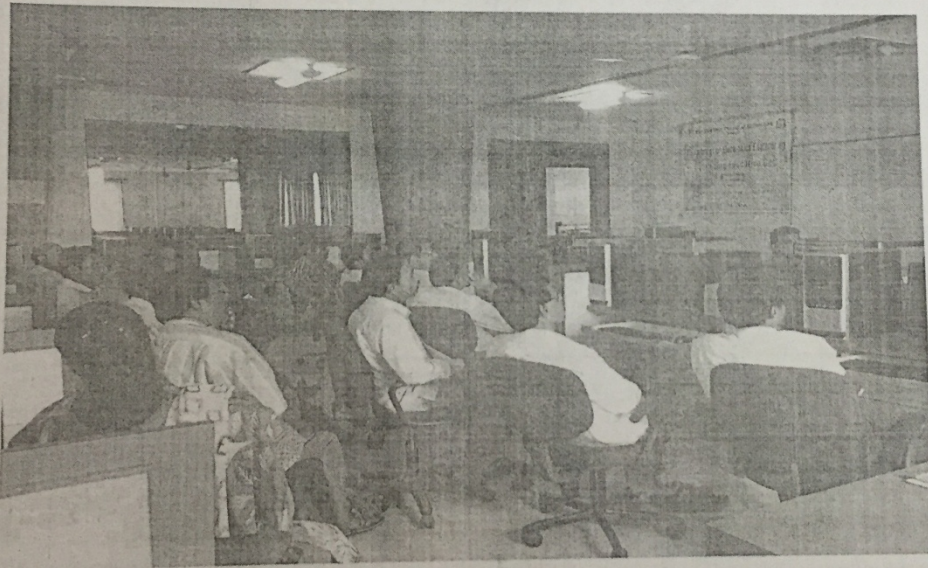

Conclusion : All the participants are satisfied and have given very good feedback about course coverage, personal attention and punctuality to start the workshop. They are very much interested to attend this type of workshop frequently in future.



Lokmanya Tilak Jankalyan Shikshan Sanstha's
PRIYADARSHINI COLLEGE OF ENGINEERING

(Recognised by A.I.C.T.E., New Delhi & Govt. of Maharashtra, Affiliated to R.T.M.Nagpur University)
Near CRPF Campus, Hingna Road, Nagpur-440 019, Maharashtra (India)
Phone : 07104 - 236381, 237307, Fax : 07104 - 237681,
email : principal.pce.ngp@gmail.com, www.pcenagpur.edu.in



PRIYADARSHINI COLLEGE OF ENGG, NAGPUR
DEPARTMENT OF ELECTRONICS ENGG
SESSION 2018-19
One day Workshop on "English Speaking".
Under Continuing Education Cell
Registration Details
30th March 2019

Sr.No.	Name of Candidate	Department	Signature	Certificate Issued
1	Mr. VM sorate	Physics		
2	Mr. NAMDEO Phalokar	IT		
3	Mr. Atul Sahare	Chem		
4	Mr. V.R. Mohalkar	Civil		
5	Mr. P. G. Ambalkar	ET	Deepak.	
6	Mr. G. J. Sambore	EN		
7	Mr. B. D. Bagde	Physics		
8	Mr. Ravi Dumbhare	ET	Ravi	
9	Mr. Sanjay Ghate	ET		
10	Mr. Rasik Ambone	ET		
11	Mr. Radhakrishnam	Civil		
12	Mr. R. M. Shelke	ME		
13	Mr. Nizuti Jichkar	Che.		
14	Mr. Y. Khengdale	EN		
15	Mr. D. P. Patil	ME		
16	Mr. Sanjay chawre	EL		
17	Mr. Krishna Pimpalkar	EL		
18	Mr. M. Sodmale	EL		
19	Mr. Vithal Sodmake	CT	Vithal.	
20	Mr. Shubham Meshram	Civil		
21	Mr. R. B. Jashi	EN	Jashi	
22	Mr. Maksud Khan	ET		
23	Mr. J. S. Bhandare	EL		
24	Mr. Laxmikant Agasti	EL		
25				
26	Mr. Devram Basewar	Chemistry		
27	Mr. Rajesh Shrivast	CT		
28	Mr. Shrikant Uge	CT		